

Mini-spectrometer



[TF series]

C13053MA

Compact and thin, built-in high-sensitivity CMOS image sensor

The mini-spectrometer TF series is a polychromator provided in a compact, thin case that houses optical elements, image sensor, and driver circuit. Spectrum data can be acquired by guiding measurement light into a mini-spectrometer through an optical fiber and transferring the measured results to a PC via the USB connection. The incorporation of a high-sensitivity CMOS image sensor maintains high sensitivity equivalent to that of a CCD and achieves low power consumption. Moreover, the trigger function that can be also used for short-term integration enables spectroscopic measurement of pulse emissions. The product includes free evaluation software with functions for setting measurement conditions, acquiring and saving data, drawing graphs, and so on. Furthermore, the DLL function specifications are disclosed, so users can create their original measurement software programs.

Features

- Compact, thin case
- High-sensitivity CMOS image sensor built in (high sensitivity equivalent to that of a CCD)
- With a trigger function
- High throughput using quartz transmission grating
- Highly accurate optical characteristics
- External power supply not necessary (USB bus powered)
- Installable in equipment
- Stores wavelength conversion factor*1 in internal memory

Applications

- Sugar content and acidity detection of foods
- Thickness gauge

*1: A conversion factor for converting the image sensor pixel number into a wavelength. A calculation factor for converting the A/D converted count into the input light level is not provided.

Optical characteristics

Parameter	Specification	Unit
Spectral response range	500 to 1100	nm
Spectral resolution (FWHM)*2	Typ.	2.5
	Max.	3.5
Wavelength reproducibility*3	-0.4 to +0.4	nm
Wavelength temperature dependence	-0.04 to +0.04	nm/°C
Spectral stray light*2 *4	-33 max.	dB

*2: When the slit in the table in "Structure" is used. The spectral resolution depends on the slit.

*3: Measured under constant light input conditions

*4: The ratio of the count measured when an 800 nm light is input to the count measured when an 800 ± 40 nm light is input.

Electrical characteristics

Parameter	Specification	Unit
A/D conversion	16	bit
Integration time	11 to 100000	μs
Interface	USB 2.0	-
USB bus power current consumption	Typ.	220
	Max.	250

Structure

Parameter	Specification	Unit
Dimensions (W × D × H)	80 × 60 × 12	mm
Weight	88	g
Image sensor	High-sensitivity CMOS linear image sensor	-
Number of pixels	512	pixels
Slit*5 (H × V)	25 × 250	μm
NA*6	0.22	-
Connector for optical fiber	SMA905	-

*5: Input slit aperture size

*6: Numeric aperture (solid angle)

Absolute maximum ratings

Parameter	Symbol	Value	Unit
Operating temperature*7	T _{opr}	+5 to +50	°C
Storage temperature*7	T _{stg}	-20 to +70	°C

*7: No dew condensation

When there is a temperature difference between a product and the surrounding area in high humidity environment, dew condensation may occur on the product surface. Dew condensation on the product may cause deterioration in characteristics and reliability.

Note: Exceeding the absolute maximum ratings even momentarily may cause a drop in product quality. Always be sure to use the product within the absolute maximum ratings.

Spectral response

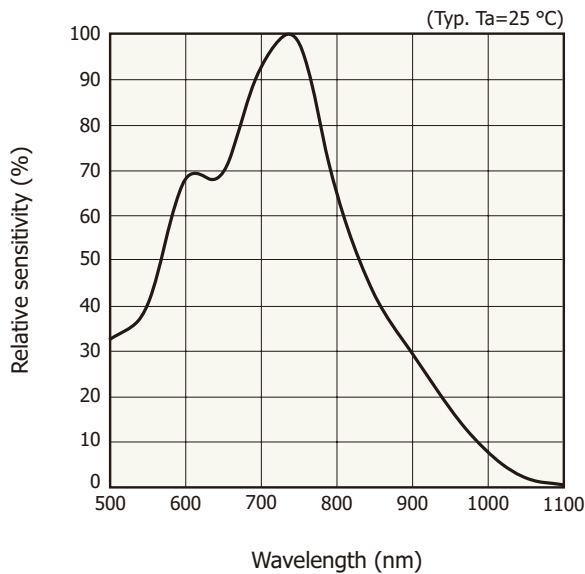

Spectral resolution vs. wavelength

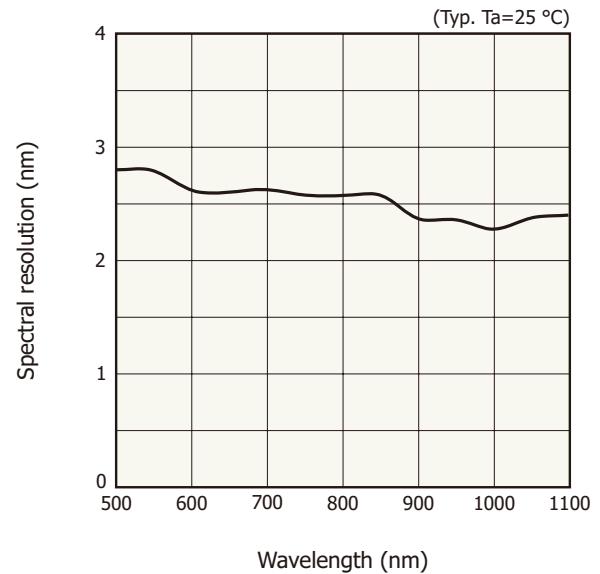

Linearity (typical example)

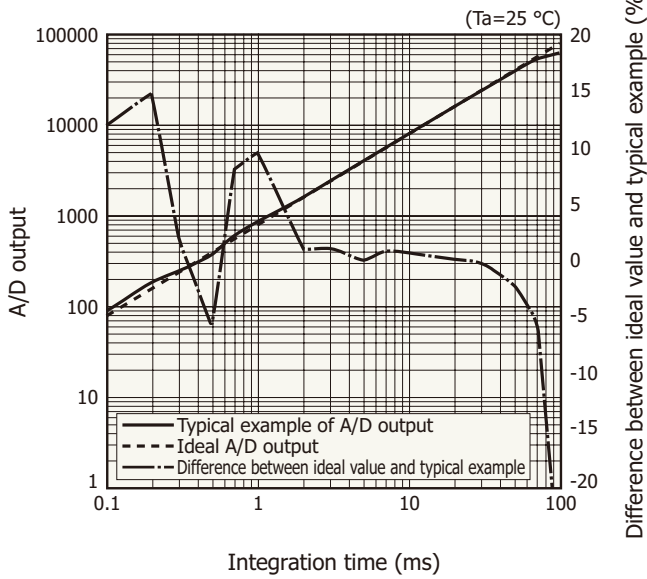

KACCB0369EB

A/D output is the output with dark output subtracted when light is input. The difference between the ideal value and typical example contains a measurement error. The smaller the A/D output, the larger the measurement error.

Dark output vs. temperature (typical example)

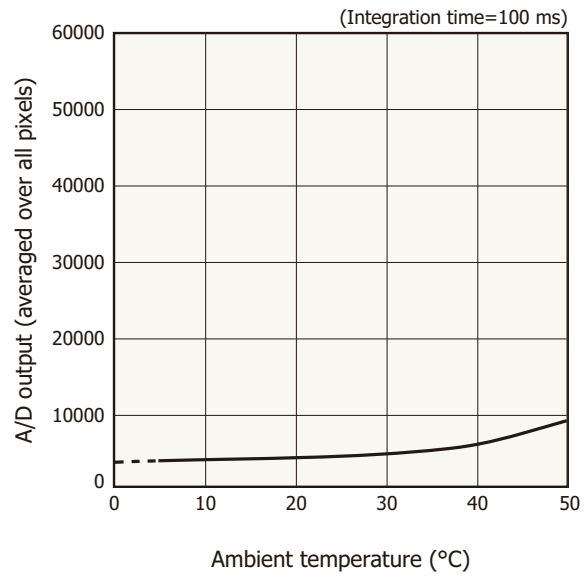

KACCB0370EB

A/D output is the sum of the sensor and circuit offset outputs and the sensor dark output.

Optical component layout

The mini-spectrometer TF series employs a transmission holographic grating made of quartz and an optical system arranged on a robust optical base to produce high throughput and highly accurate optical characteristics.

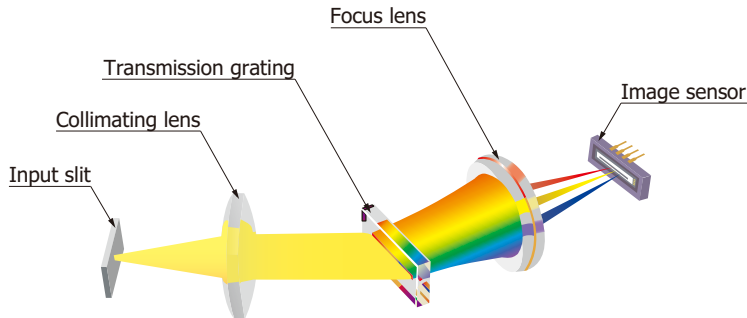

KACCC0256EA

Connection example (transmitted light measurement)

Spectrum data can be acquired by guiding measurement light into a mini-spectrometer through an optical fiber and transferring the measured results to a PC via the USB connection. Since there are no moving parts inside the device, constantly stable measurements can be expected. Moreover, the optical guiding section uses an optical fiber making connection to the measured object flexible.

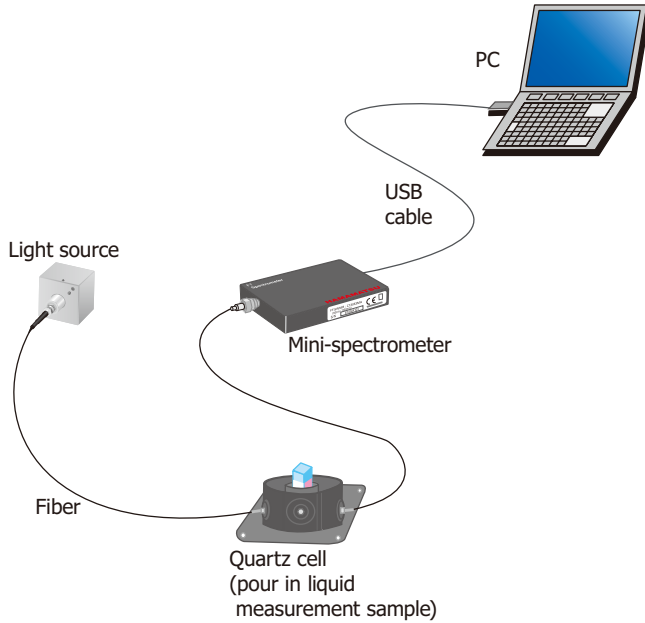

KACCC0767EC

Trigger operation modes

In the C13053MA, the following trigger operation modes are available. You can switch between these modes from the evaluation software supplied with the C13053MA.

(1) Asynchronous data measurement at software trigger input

The first piece of digital data that is converted after a software trigger is applied from the PC is acquired.

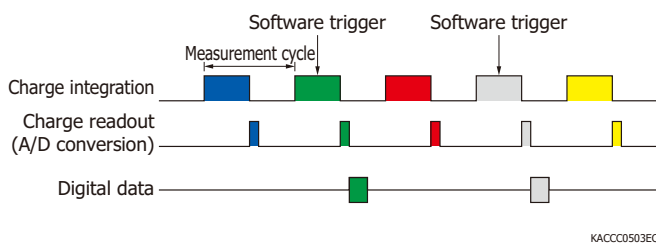

KACCC0503EC

(2) Synchronous data measurement at software trigger input

Sensor operation (integration) starts when a software trigger is applied from the PC.

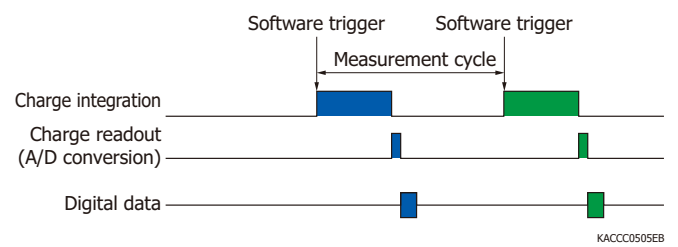

KACCC0505EB

(3) Asynchronous data measurement at external trigger input

The first piece of digital data that is converted after an external trigger edge (rising or falling edge can be specified) is applied to the external trigger terminal is acquired.

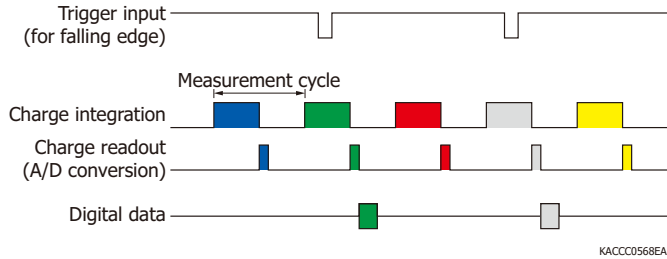

(4) Synchronous data measurement at external trigger input

Sensor operation (integration) starts when an external trigger edge (rising or falling edge can be specified) is applied to the external trigger terminal, and then the digital data is acquired.

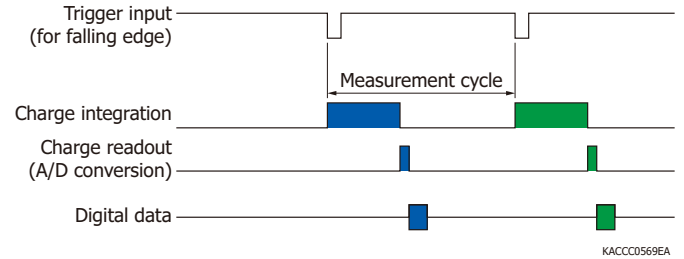

(5) Asynchronous data measurement at external trigger input level

Digital data is acquired when an external trigger (high level or low level can be specified) is applied to the external trigger terminal.

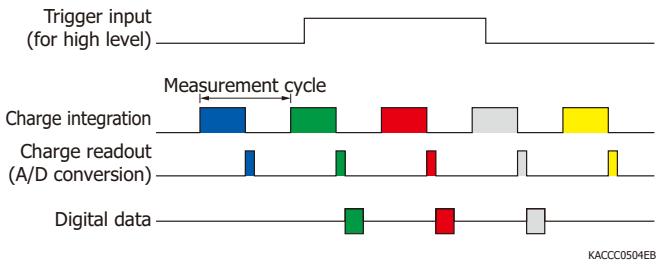

(6) Synchronous data measurement at external trigger input level

Sensor operation (integration) starts when a trigger (high level or low level can be specified) is applied to the external trigger terminal, and then the digital data is acquired.

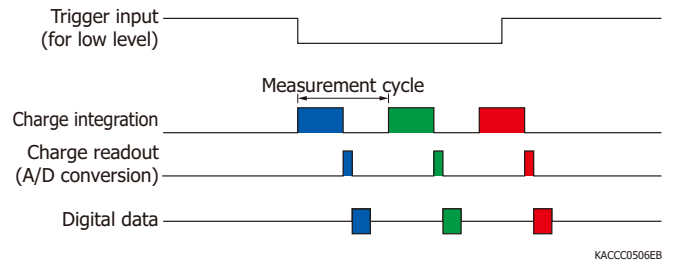

In any of the modes 1 to 6, if the trigger input cycle is shorter than the measurement cycle of the spectrometer, the input trigger is ignored.

(7) External trigger signal output

The start timing (pulse width: 10 μ s) of integration can be output from the external trigger terminal (trigger output edge: rising or falling edge can be specified).

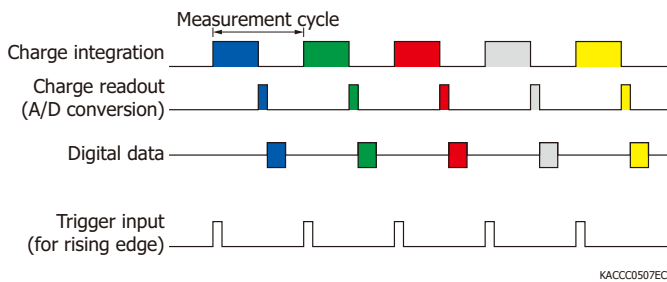

Evaluation software (accessory)

By installing the evaluation software (SpecEvaluationUSB2.exe)*8 into a PC, you can perform the following basic operations.

- Acquire and save measured data
- Set measurement conditions
- Module information acquisition (wavelength conversion factor, mini-spectrometer type, etc.)
- Display graphs
- Arithmetic functions
 - Pixel number to wavelength conversion
 - Calculation in comparison with reference data (transmittance, reflectance)
 - Dark subtraction
 - Gaussian approximation (peak position and count, FWHM)

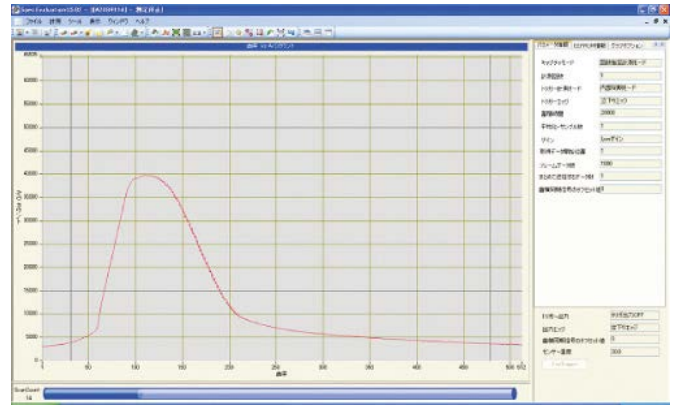

Note: Up to eight mini-spectrometers can be connected to a single PC.

*8: Compatible OS: Microsoft Windows 10 Professional (32-bit, 64-bit)

A DLL for controlling the hardware is available.

Users can develop original measurement programs using the following development platform.

Microsoft Visual Studio® 2008 (SP1) Visual C++®

Microsoft Visual Studio 2008 (SP1) Visual Basic®

Note: Microsoft, Windows, Visual Studio, Visual C++, and Visual Basic are either registered trademarks or trademarks of Microsoft Corporation in the United States and/or other countries.

Dimensional outline (unit: mm)

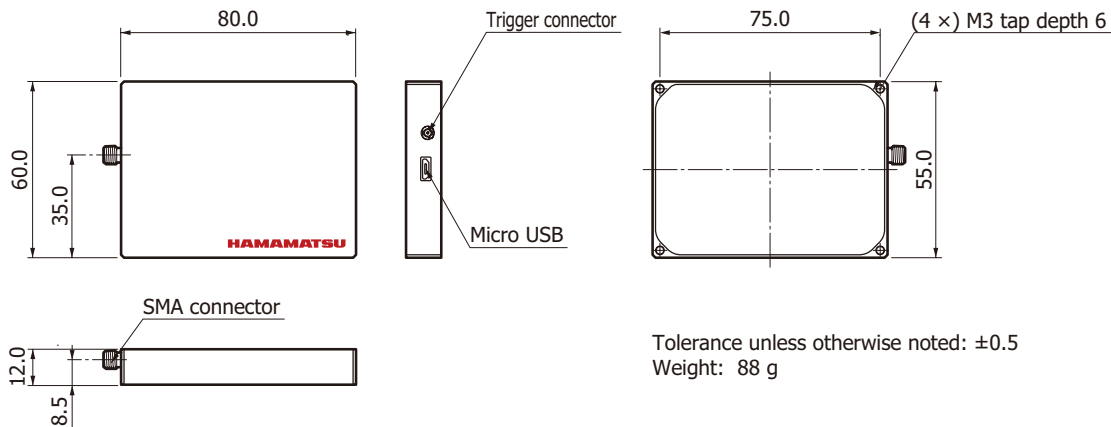

Tolerance unless otherwise noted: ±0.5
Weight: 88 g

KACCA0355EB

Accessories

- USB cable
- Dedicated software (evaluation software, sample software, DLL)

Options (sold separately)

- Input optical fiber

Type no.	Product name	Core diameter (μm)	Specification
A16963-01	Fiber for visible/near infrared range	600	NA=0.22, length=1.5 m, With SMA905D connector on each end

- Coaxial cable for external trigger input A12763

Dimensional outline (unit: mm)

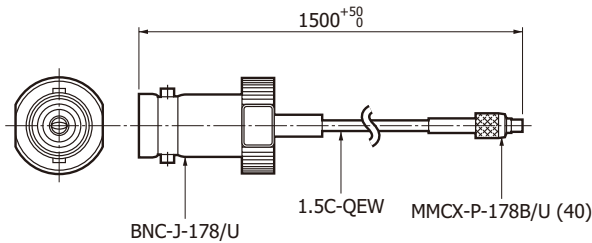

KACCA0358EA

Related information

www.hamamatsu.com/sp/ssd/doc_en.html

Precautions

- Disclaimer
- Mini-spectrometers

Technical information

- Mini-spectrometers

Information described in this material is current as of June 2024.

Product specifications are subject to change without prior notice due to improvements or other reasons. This document has been carefully prepared and the information contained is believed to be accurate. In rare cases, however, there may be inaccuracies such as text errors. Before using these products, always contact us for the delivery specification sheet to check the latest specifications.

The product warranty is valid for one year after delivery and is limited to product repair or replacement for defects discovered and reported to us within that one year period. However, even if within the warranty period we accept absolutely no liability for any loss caused by natural disasters or improper product use. Copying or reprinting the contents described in this material in whole or in part is prohibited without our prior permission.

HAMAMATSU

www.hamamatsu.com

HAMAMATSU PHOTONICS K.K., Solid State Division

1126-1 Ichino-cho, Chuo-ku, Hamamatsu City, 435-8558 Japan, Telephone: (81)53-434-3311, Fax: (81)53-434-5184

U.S.A.: HAMAMATSU CORPORATION: 360 Foothill Road, Bridgewater, NJ 08807, U.S.A., Telephone: (1)908-231-0960, Fax: (1)908-231-1218

Germany: HAMAMATSU PHOTONICS DEUTSCHLAND GMBH: Arzbergerstr. 10, 82211 Herrsching am Ammersee, Germany, Telephone: (49)8152-375-0, Fax: (49)8152-265-8 E-mail: info@hamamatsu.de

France: HAMAMATSU PHOTONICS FRANCE S.A.R.L.: 19 Rue du Saule Trapu, Parc du Moulin de Massy, 91882 Massy Cedex, France, Telephone: (33)1 69 53 71 00, Fax: (33)1 69 53 71 10 E-mail: infos@hamamatsu.fr

United Kingdom: HAMAMATSU PHOTONICS UK LIMITED: 2 Howard Court, 10 Tewin Road, Welwyn Garden City, Hertfordshire, AL7 1BW, UK, Telephone: (44)1707-294888, Fax: (44)1707-325777 E-mail: info@hamamatsu.co.uk

North Europe: HAMAMATSU PHOTONICS NORDEN AB: Torshamnsgatan 35, 16440 Kista, Sweden, Telephone: (46)8-509-031-00, Fax: (46)8-509-031-01 E-mail: info@hamamatsu.se

Italy: HAMAMATSU PHOTONICS ITALIA S.R.L.: Strada della Moia, 1 int. 6 20044 Arese (Milano), Italy, Telephone: (39)02-93 58 17 33, Fax: (39)02-93 58 17 41 E-mail: info@hamamatsu.it

China: HAMAMATSU PHOTONICS (CHINA) CO., LTD.: 1201, Tower B, Jianning Center, 27 Dongsanhuan Bellu, Chaoyang District, 100020 Beijing, P.R. China, Telephone: (86)10-6586-6006, Fax: (86)10-6586-2866 E-mail: hpc@hamamatsu.com.cn

Taiwan: HAMAMATSU PHOTONICS TAIWAN CO., LTD.: 13F-1, No.101, Section 2, Gongdao 5th Road, East Dist., Hsinchu City, 300046, Taiwan(R.O.C) Telephone: (886)3-659-0080, Fax: (886)3-659-0081 E-mail: info@hamamatsu.com.tw