



L13072 series

Peak emission wavelength: 1.2 μm

The L13072 series is a high-power LED that emits infrared light at a peak wavelength of 1.2 μm. The LED is suitable for applications requiring use of an infrared emitter with InGaAs photodiode.

Features

- High output
- High reliability
- Compact, surface mount type package (1.6 × 0.8 × 0.7^t mm): L13072-0120G
- Supports lead-free reflow soldering

Applications

- Gas detection
- Analytical instruments
- Near infrared lighting

Structure

Type no.	Package	Window material
L13072-0120G	Glass epoxy	Silicone resin
L13072-0120K	TO-46	Borosilicate glass
L13072-0120L	TO-46	Lens type borosilicate glass
L13072-0120P	Plastic	Bullet-shaped epoxy resin

Absolute maximum ratings (Ta=25 °C, unless otherwise noted)

Type no.	Reverse voltage VR (V)	Forward current IF (mA)	Forward current decrease rate Ta > 25 °C (mA/°C)	Pulse forward current IFP*1 (A)	Pulse forward current decrease rate Ta > 25 °C (mA/°C)	Power dissipation P (mW)	Operating temperature Topr*2 (°C)	Storage temperature Tstg*2 (°C)	Soldering temperature Tsol (°C)
L13072-0120G	1.0	80	1.1	0.5	6.7	150	-30 to +85	-40 to +100	250 (twice)*3
L13072-0120K				1.0	13				-
L13072-0120L		1.0	10	-					
L13072-0120P		100	1.0	1.0	10				-

*1: Pulse width=10 μs, duty ratio=1%

*2: No dew condensation

When there is a temperature difference between a product and the surrounding area in high humidity environments, dew condensation may occur on the product surface. Dew condensation on the product may cause deterioration in characteristics and reliability.

*3: Reflow soldering, JEDEC J-STD-020 MSL 2a, see P.8

Note: Exceeding the absolute maximum ratings even momentarily may cause a drop in product quality. Always be sure to use the product within the absolute maximum ratings.

Electrical and optical characteristics (Ta=25 °C)

Type no.	Peak emission wavelength λ_p If=50 mA			Spectral half width $\Delta\lambda$ If=50 mA	Radiant flux ϕ_c If=50 mA		Forward voltage V_F If=50 mA		Reverse current I_R $V_R=1V$	Cutoff frequency f_c^{*4}	
	Min. (nm)	Typ. (nm)	Max. (nm)	Typ. (nm)	Min. (mW)	Typ. (mW)	Typ. (V)	Max. (V)	Max. (μA)	Min. (MHz)	Typ. (MHz)
L13072-0120G	1150	1200	1250	80	3.2	4.4	1.1	1.4	10	10	15
L13072-0120K					1.5	2.2	1.1	1.6			
L13072-0120L					2.2	3.2	1.1	1.5			
L13072-0120P					-	5.0	1.1	1.5			

*4: If=50 mA \pm 10 mA p-p, frequency at which the light output drops by 3 dB relative to the output at 100 kHz

Emission spectrum

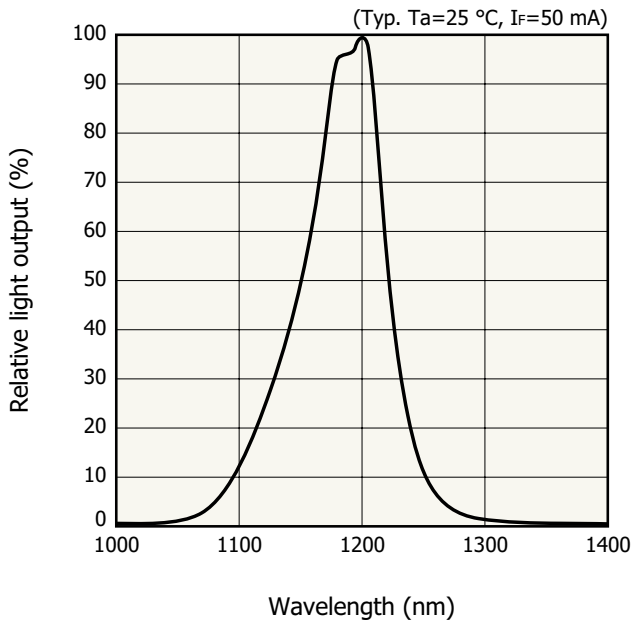

KLED80430EA

Radiant flux vs. pulse forward current

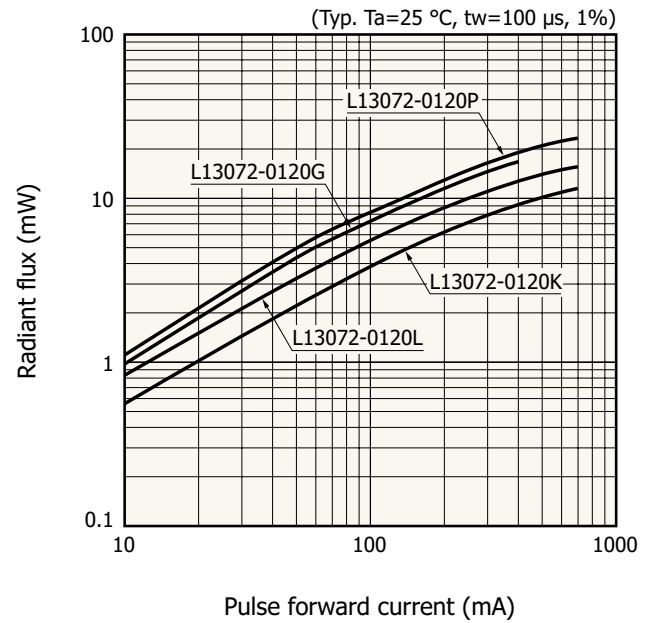

KLED80431EC

Pulse forward current vs. pulse forward voltage

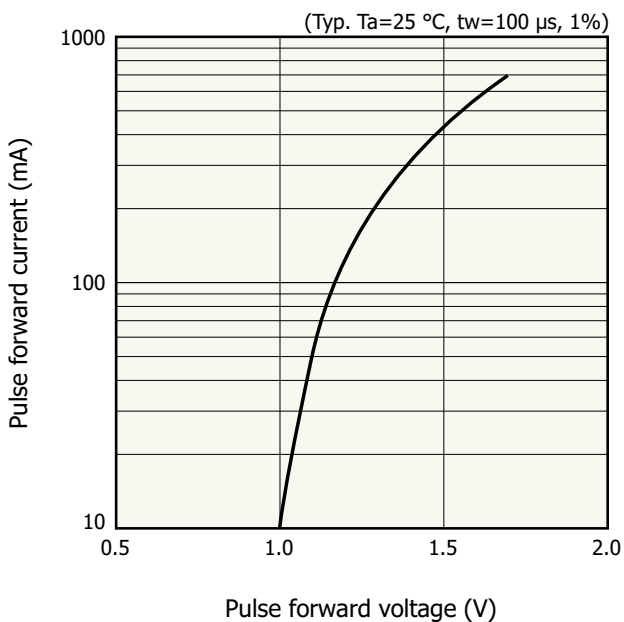

KLED80432EA

Directivity

L13072-0120G

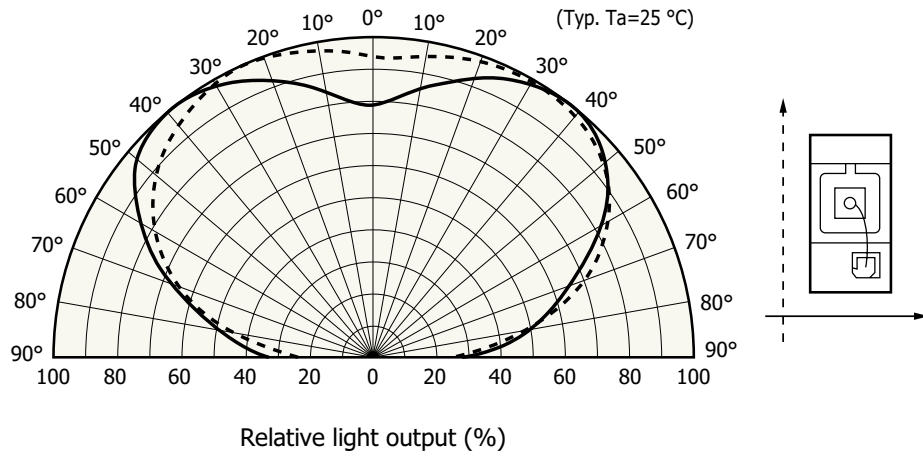

KLEDB0487EB

L13072-0120K/-0120L/-0120P

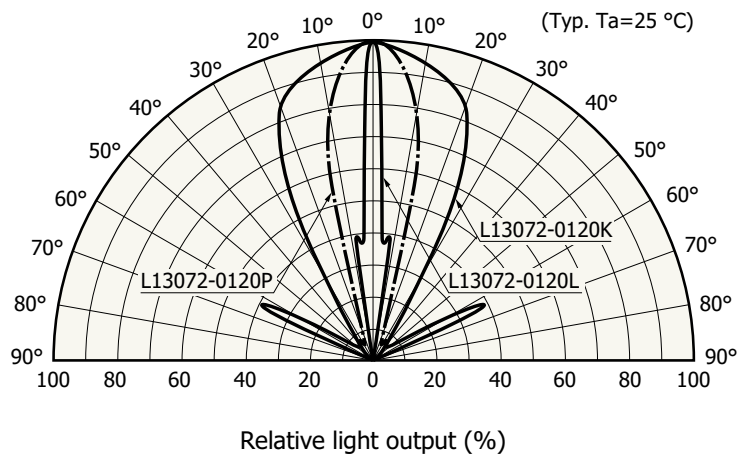

KLEDB0433EB

Light output vs. ambient temperature

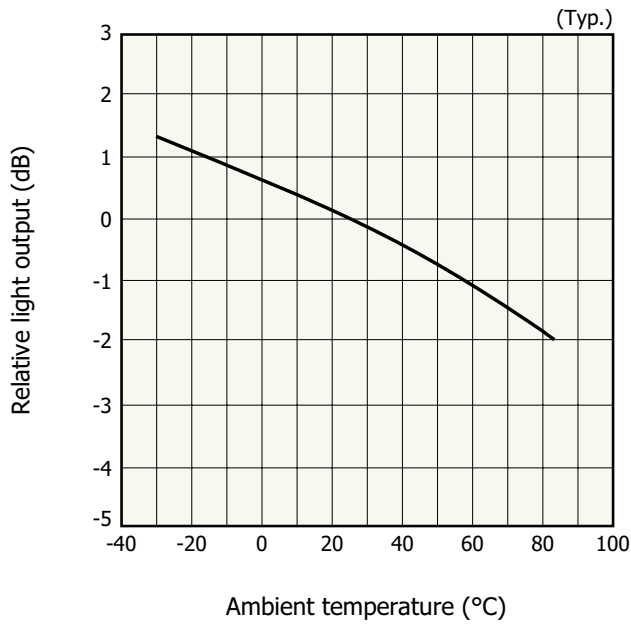

KLEDB0434EB

Allowable forward current vs. ambient temperature

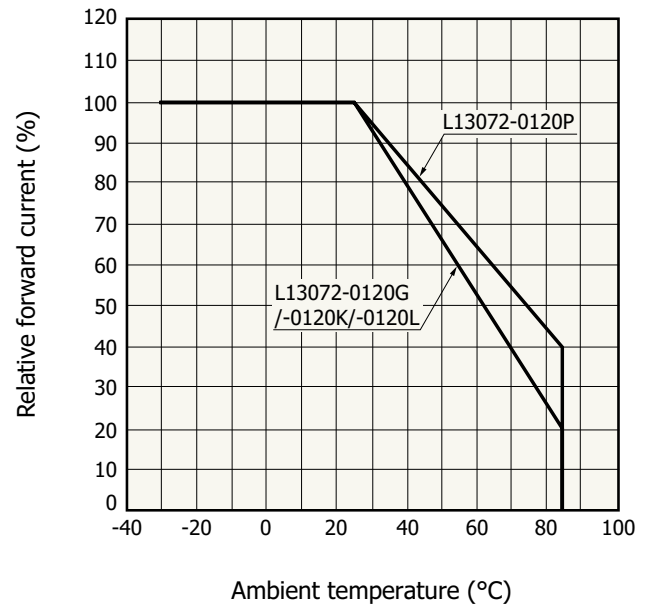

KLEDB0478EA

Allowable forward current vs. duty ratio

L13072-0120G

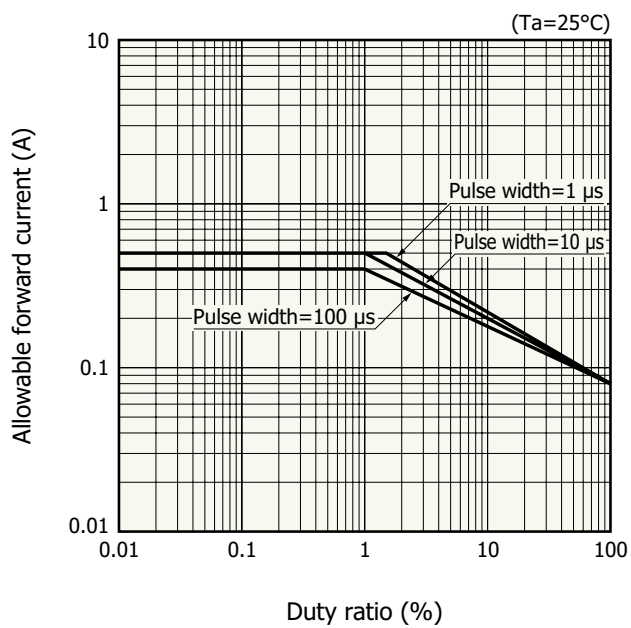

KLEDB0516EB

L13072-0120K/-0120L

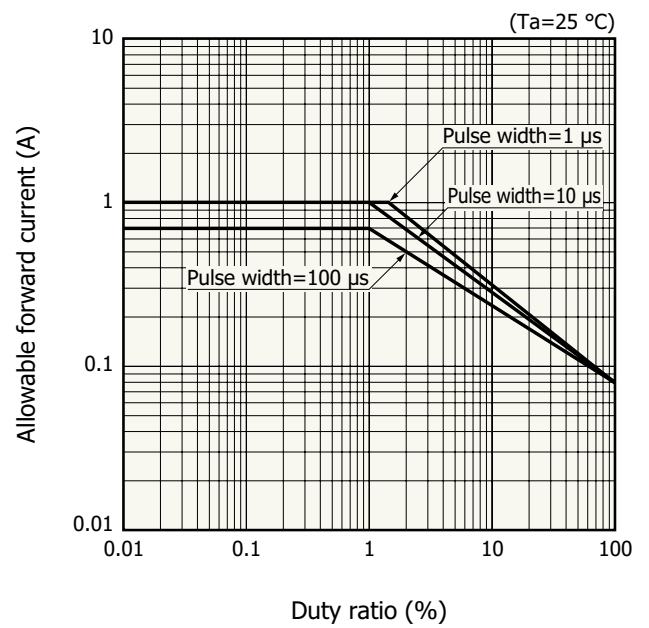

KLEDB0225EC

L13072-0120P

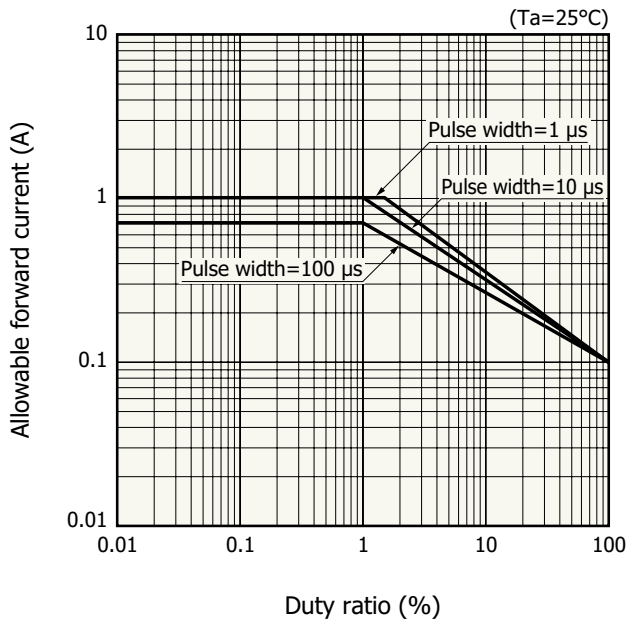

KLEDB0479EAB

Dimensional outlines (unit: mm)

L13072-0120G

Recommended land pattern

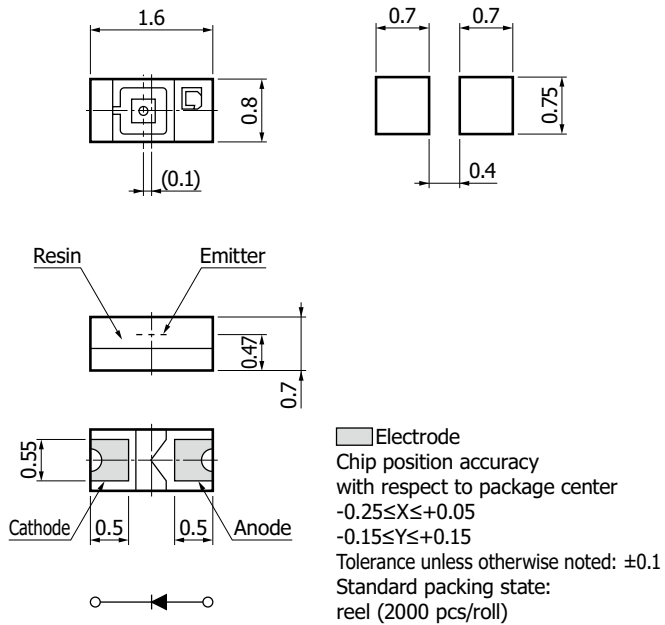

KLEDA0107EB

L13072-0120K

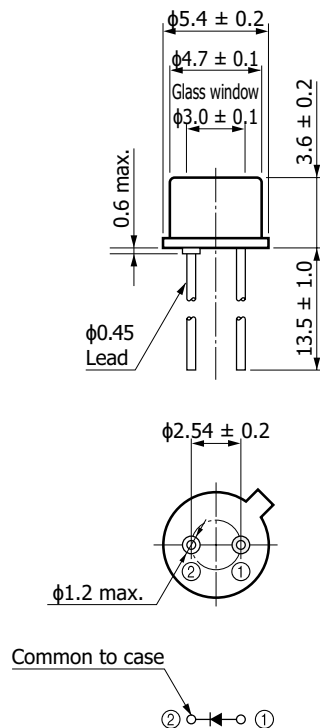

KLEDA0103EB

L13072-0120L

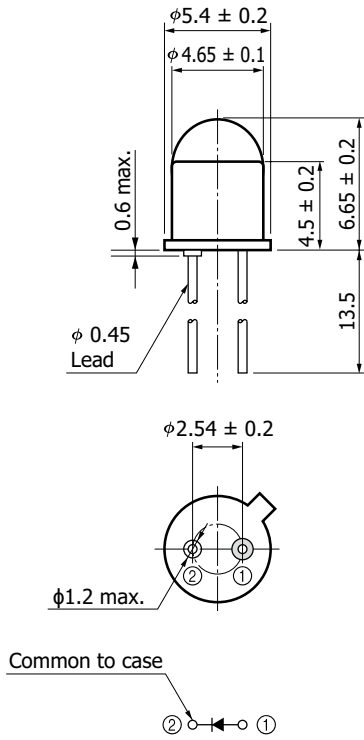

KLEDA0092EB

L13072-0120P

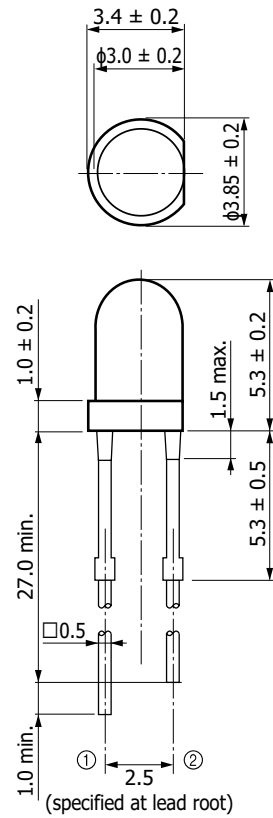

Standard packing state:
anti-static bag
(100 pcs/pack)

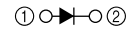

KLEDA0098EC

Standard packing specifications (L13072-0120G)

■ Reel (conforms to JEITA ET-7200)

Outer diameter	Hub diameter	Tape width	Material	Electrostatic characteristics
φ180 mm	φ60 mm	8 mm	PS	Conductive

■ Embossed tape (unit: mm, material: PS, conductive)

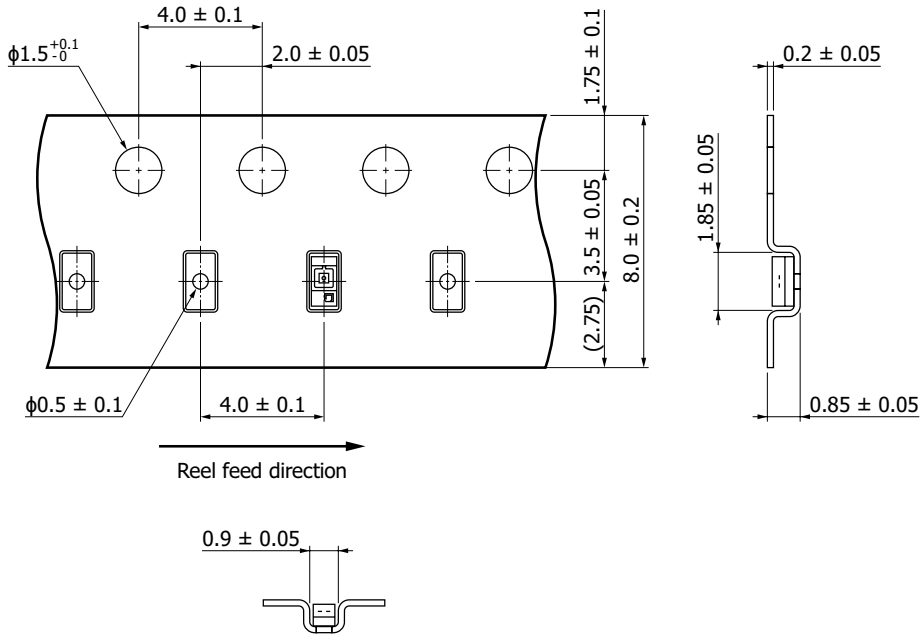

KLEDC0063EA

■ Packing quantity

2000 pcs/reel

■ Packing stage

Reel and desiccant in moisture-proof packaging (vacuum-sealed)

Recommended soldering conditions

L13072-0120G

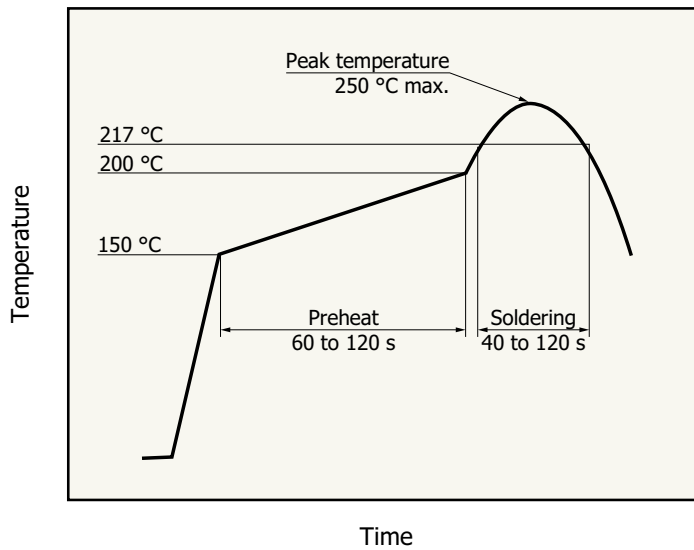

KLEDB0536EC

- After unpacking, store the device in an environment at a temperature range of 5 to 30 °C and a humidity of 60% or less, and perform reflow soldering within 4 week.
- The effect that the product receives during reflow soldering varies depending on the circuit board and reflow oven that are used. When you set reflow soldering conditions, check that problems do not occur in the product by testing out the conditions in advance.

L13072-0120K/-0120L

- Solder temperature: 260 °C (5 s or less, once)
Solder the leads at a point at least 1 mm away from the package body.

L13072-0120P

- Solder temperature: 230 °C (5 s or less, once)
Solder the leads at a point at least 2 mm away from the package body.

Note: When you set soldering conditions, check that problems do not occur in the product by testing out the conditions in advance.

Baking (L13072-0120G)

If more than 12 months have passed in the unopened state or storage conditions are exceeded after opening the package, baking is required to remove moisture before reflow soldering. For the baking, refer to "Precautions / Surface mount type products" in the related information.

Recommended baking conditions

- Temperature: 150 °C (3 hours, once)

Note: When you set baking conditions, perform experiments to confirm that no problems occur with the product.

Related information

www.hamamatsu.com/sp/ssd/doc_en.html

■ Precautions

- Disclaimer
- Safety consideration / Opto-semiconductors
- Precautions / Surface mount type products
- Precautions / Compound opto-semiconductors (photosensors, light emitters)

■ Catalogs

- Selection guide / LED
- Technical note / LED

Information described in this material is current as of November 2024.

Product specifications are subject to change without prior notice due to improvements or other reasons. This document has been carefully prepared and the information contained is believed to be accurate. In rare cases, however, there may be inaccuracies such as text errors. Before using these products, always contact us for the delivery specification sheet to check the latest specifications.

The product warranty is valid for one year after delivery and is limited to product repair or replacement for defects discovered and reported to us within that one year period. However, even if within the warranty period we accept absolutely no liability for any loss caused by natural disasters or improper product use. Copying or reprinting the contents described in this material in whole or in part is prohibited without our prior permission.

HAMAMATSU

www.hamamatsu.com

HAMAMATSU PHOTONICS K.K., Solid State Division

1126-1 Ichino-cho, Chuo-ku, Hamamatsu City, 435-8558 Japan, Telephone: (81)53-434-3311, Fax: (81)53-434-5184

U.S.A.: HAMAMATSU CORPORATION: 360 Foothill Road, Bridgewater, NJ 08807, U.S.A., Telephone: (1)908 231 0960, Fax: (1)908 231 1218

Germany: HAMAMATSU PHOTONICS DEUTSCHLAND GMBH: Arzbergerstr. 10, 82211 Herrsching am Ammersee, Germany, Telephone: (49)8152 375 0, Fax: (49)8152 265 8 E mail: info@hamamatsu.de

France: HAMAMATSU PHOTONICS FRANCE S.A.R.L.: 19 Rue du Saule Trapu, Parc du Moulin de Massy, 91882 Massy Cedex, France, Telephone: (33)1 69 53 71 00, Fax: (33)1 69 53 71 10 E mail: infos@hamamatsu.fr

United Kingdom: HAMAMATSU PHOTONICS UK LIMITED: 2 Howard Court, 10 Tewin Road, Welwyn Garden City, Hertfordshire, AL7 1BW, UK, Telephone: (44)1707 294888, Fax: (44)1707 325777 E mail: info@hamamatsu.co.uk

North Europe: HAMAMATSU PHOTONICS NORDEN AB: Torshamnsgatan 35, 16440 Kista, Sweden, Telephone: (46)8 509 031 00, Fax: (46)8 509 031 01 E mail: info@hamamatsu.se

Italy: HAMAMATSU PHOTONICS ITALIA S.R.L.: Strada della Moia, 1 int. 6 20044 Arese (Milano), Italy, Telephone: (39)02 93 58 17 33, Fax: (39)02 93 58 17 41 E mail: info@hamamatsu.it

China: HAMAMATSU PHOTONICS (CHINA) CO., LTD.: 1201, Tower B, Jiaming Center, 27 Dongsanhuan Beilu, Chaoyang District, 100020 Beijing, P.R. China, Telephone: (86)10 6586 6006, Fax: (86)10 6586 2866 E mail: hpc@hamamatsu.com.cn

Taiwan: HAMAMATSU PHOTONICS TAIWAN CO., LTD.: 13F 1, No.101, Section 2, Gongdao 5th Road, East Dist., Hsinchu City, 300046, Taiwan(R.O.C) Telephone: (886)3 659 0080, Fax: (886)3 659 0081 E mail: info@hamamatsu.com.tw