

Si photodiodes with preamp

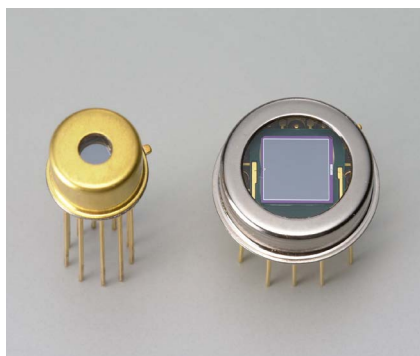

S8745-01/-06, S8746-01

Photodiode and preamp integrated with feedback resistance and capacitance

The S8745-01 and S8746-01 are low-noise sensors consisting of Si photodiode, op amp, feedback resistance and capacitance, all integrated into a small package. By simply connecting to a power supply, they can be used in low-light-level measurement such as analytical equipment and measurement equipment. The S8745-01 and S8746-01 are for ultraviolet to near infrared region, and the S8745-06 achieves high sensitivity in the visible to near infrared region. The photosensitive area of the photodiode is internally connected to the GND terminal making it highly resistant to EMC noise.

Features

- Use low power consumption FET input operational amplifier
- Built-in $R_f=1\text{ G}\Omega$ and $C_f=5\text{ pF}$
- Variable gain with an externally connected resistor
- Low noise, low NEP
- Package with shielding effect
- Highly resistance to EMC noise

Applications

- Spectrophotometry
- Optical measurement equipment

The S8745-01/-06 and S8746-01 may be damaged by electro static discharge, etc. Please see precautions in the last page.

Structure

Parameter	Symbol	S8745-01	S8745-06	S8746-01	Unit
Photosensitive area	A	2.4 × 2.4		5.8 × 5.8	mm
Package	-	TO-5		TO-8	-
Window material	-	Quartz glass	Borosilicate glass	Quartz glass	-

Absolute maximum ratings (Ta=25 °C)

Parameter	Symbol	Value	Unit
Supply voltage (op amp)	Vcc	±20	V
Power dissipation	P	500	mW
Operating temperature*1	Topr	-20 to +60	°C
Storage temperature*1	Tstg	-30 to +80	°C

*1: No dew condensation

When there is a temperature difference between a product and the surrounding area in high humidity environments, dew condensation may occur on the product surface. Dew condensation on the product may cause deterioration in characteristics and reliability.

Note: Exceeding the absolute maximum ratings even momentarily may cause a drop in product quality. Always be sure to use the product within the absolute maximum ratings.

Electrical and optical characteristics (Typ. Ta=25 °C, Vcc=±15 V, RL=1 MΩ, unless otherwise noted)

Parameter	Symbol	Condition	S8745-01	S8745-06	S8746-01	Unit
Spectral response range	λ		190 to 1100	340 to 1100	190 to 1100	nm
Peak sensitivity wavelength	λ_p		960			nm
Feedback resistance (built-in)	Rf		1			GΩ
Feedback capacitance (built-in)	Cf		5			pF
Photosensitivity	S	$\lambda=200$ nm	0.12	-	0.12	V/nW
		$\lambda=\lambda_p$	0.52	0.6	0.52	
Output noise voltage	Vn	Dark state, f=10 Hz	6	4.2	7	$\mu\text{V rms}/\text{Hz}^{1/2}$
		Dark state, f=20 Hz	5	4.1	6	
Noise equivalent power	NEP	$\lambda=\lambda_p$, f=10 Hz	11	8	15	$\text{fW}/\text{Hz}^{1/2}$
		$\lambda=\lambda_p$, f=20 Hz	11	8	15	
Output offset voltage	Vos	Dark state	±4	±2	±4	mV
Cutoff frequency	fc	-3 dB	32			Hz
Output voltage swing	Vo		13			V
Supply current	Icc+	Dark state	0.3			mA
	Icc-	Dark state	-0.3			mA

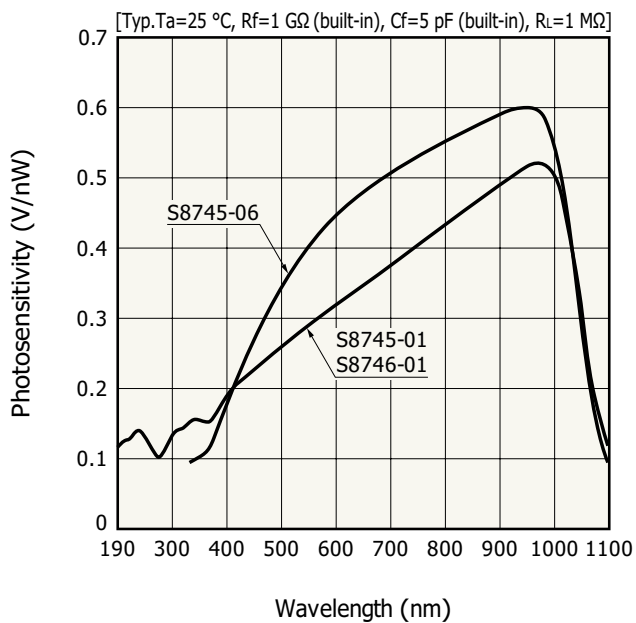
[Figure 1] Spectral response

KSPDB0232EB

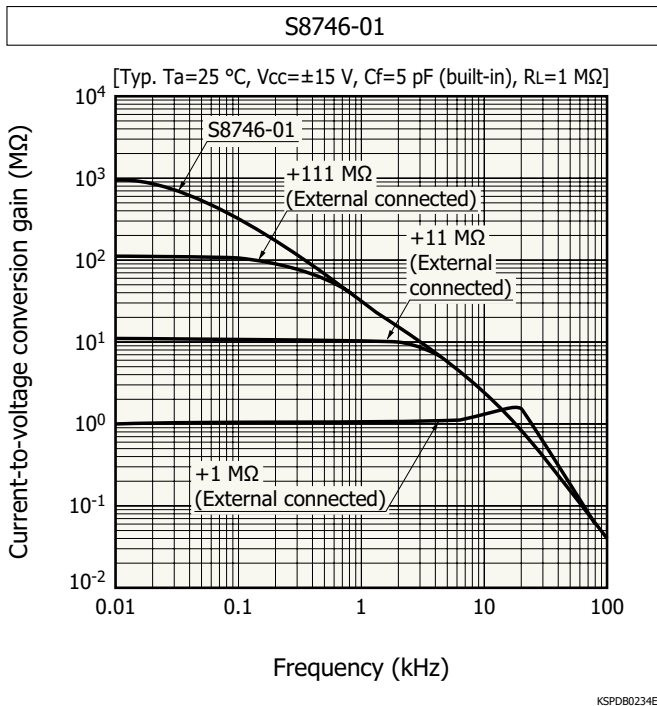
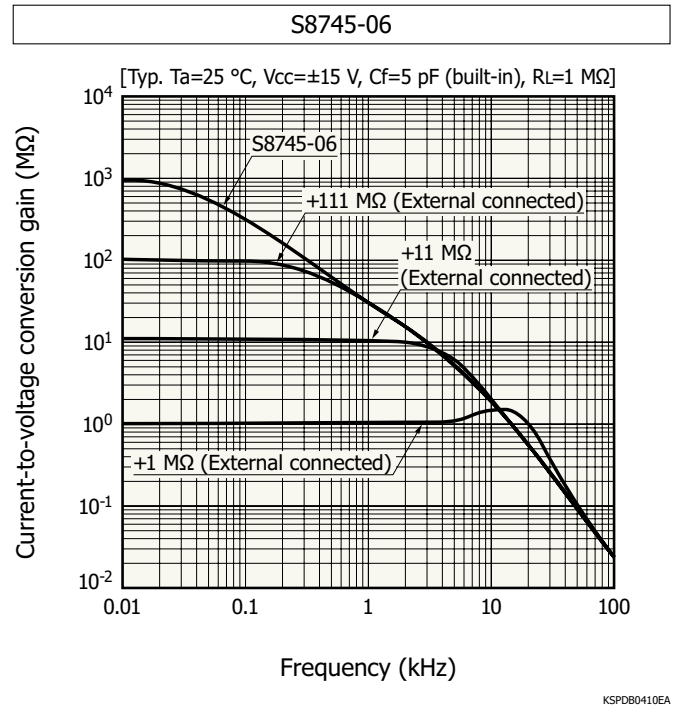
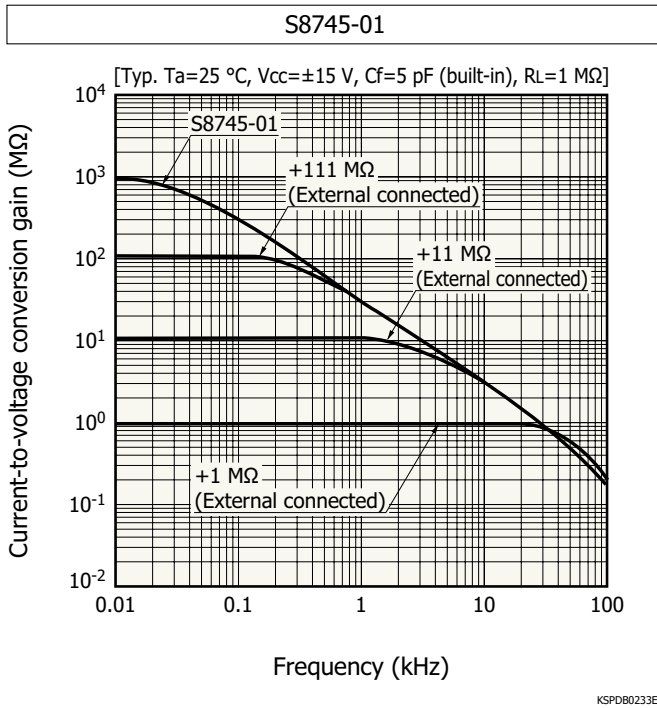
[Figure 2] Current-to-voltage conversion gain vs. frequency

The current-to-voltage conversion gain can be varied by connecting an external feedback resistor between pins 4 and 6 for the S8745-01/-06, and between pins 9 and 12 for the S8746-01 [Figure 5]. Figure 2 shows the frequency response characteristics of the S8745-01/-06 and S8746-01 with or without an externally connected feedback resistor. Because the S8745-01/-06 and S8746-01 have a built-in resistor of $1\text{ G}\Omega$, for example the total feedback resistance will be converted to $100\text{ M}\Omega$ by externally connecting a resistor of $111\text{ M}\Omega$. Choose the desired constant according to the incident light level to be detected.

Note: If the external feedback resistor is $1\text{ M}\Omega$ or less, gain peaking may occur in the frequency response. Therefore, be sure to connect a matched feedback capacitor for phase compensation.

[Figure 3] Output noise voltage vs. frequency

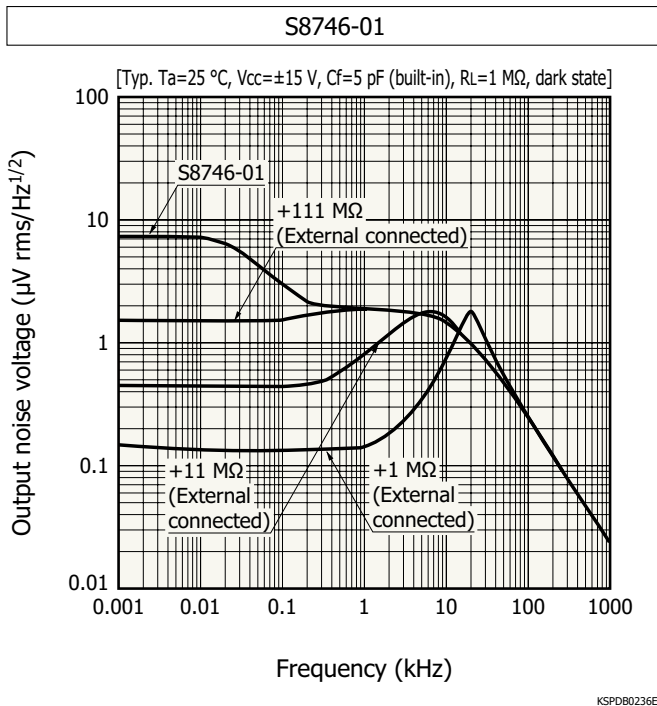
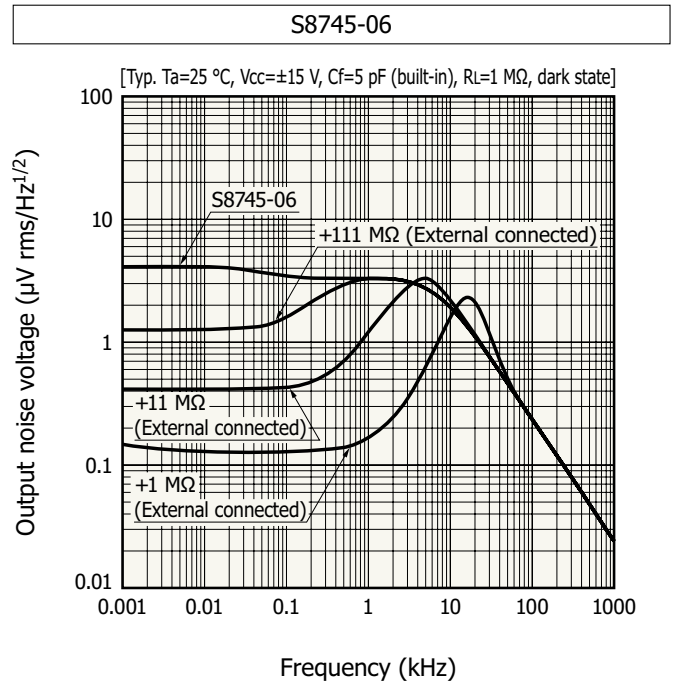
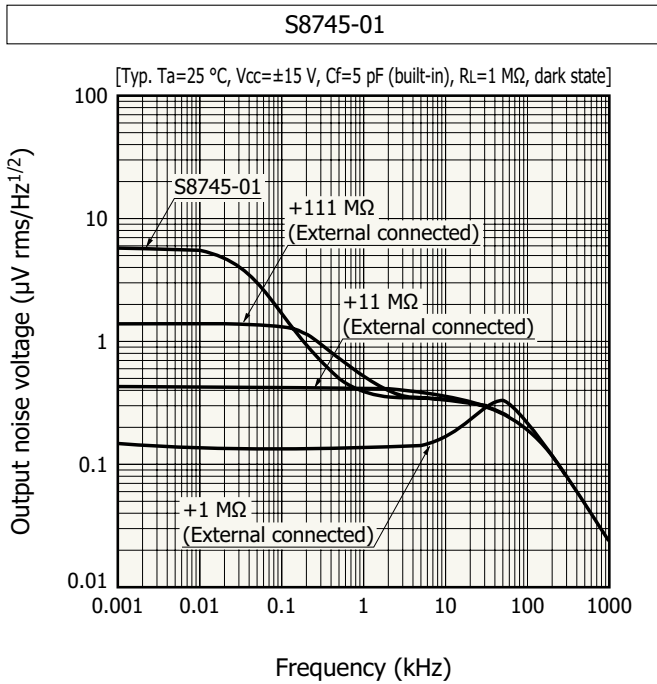

Output noise voltage and NEP (noise equivalent power) characteristics allow you to check whether the device can detect the low-level light you want to measure. Since NEP is given by the equation (1) as shown at the right, NEP at wavelengths other than λ_p can be easily calculated from Figure 1 and Figures 4.

Note: When the S8745-01/-06 and S8746-01 are used only with the internal current-to-voltage gain, it is recommended that the "-IN" lead (pin 6 for the S8745-01/-06; pin 9 for the S8746-01) be cut off to a short length in order to reduce the influence of external noise as much as possible.

$$NEP(f, \lambda) = \frac{V_n(f)}{G_{i-v}(f) \cdot S_{si}(\lambda)} = \frac{NEP(f, \lambda_p) \cdot S(\lambda_p)}{S(\lambda)} \dots (1)$$

$NEP(f, \lambda)$: NEP at specific frequency and wavelength

$NEP(f, \lambda_p)$: NEP at peak wavelength [Figure 4]

$G_{i-v}(f)$: Current-to-voltage conversion gain [Figure 2]

$S_{si}(\lambda)$: Photosensitivity of Si photodiode

$S(\lambda)$: Photosensitivity of S8745-01/-06 and S8746-01 [Figure 1]

$S(\lambda_p)$: Photosensitivity of S8745-01/-06 and S8746-01 at peak wavelength [Figure 1]

$V_n(f)$: Output noise voltage at specific frequency [Figure 3]

[Figure 4] NEP vs. frequency

S8745-01

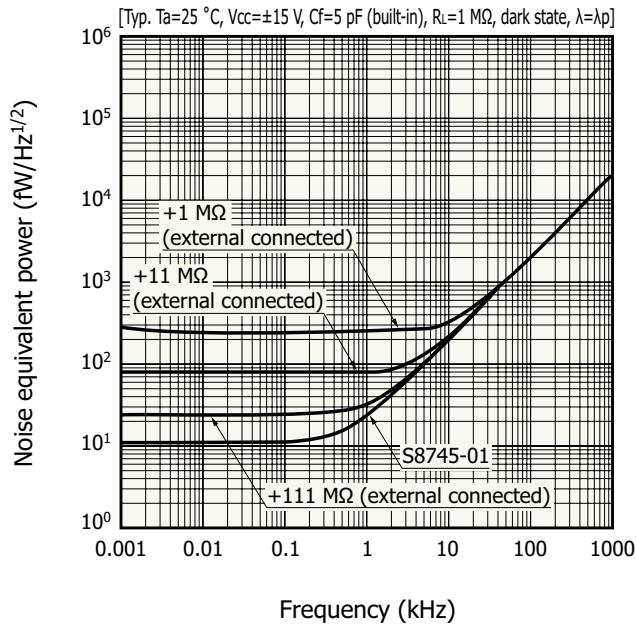

S8745-06

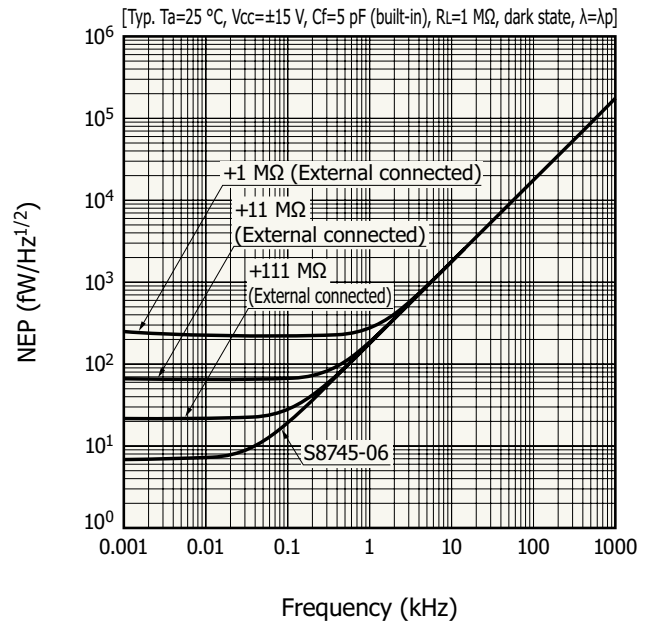

S8746-01

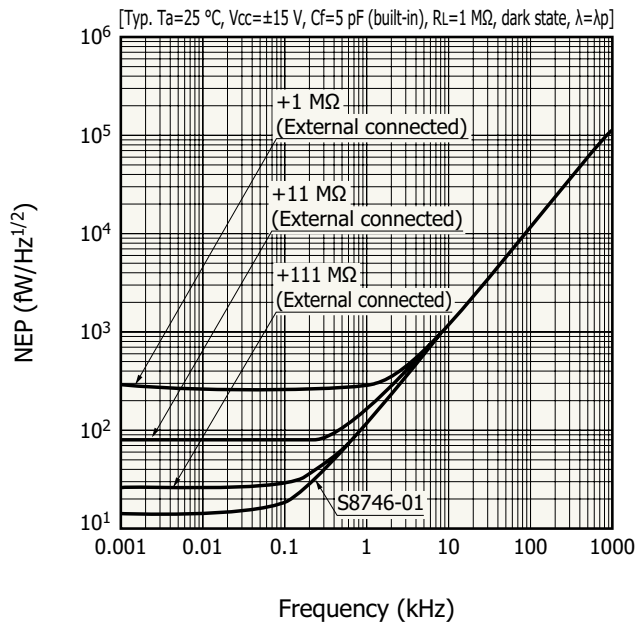

[Figure 5] Application circuit examples

S8745-01/-06

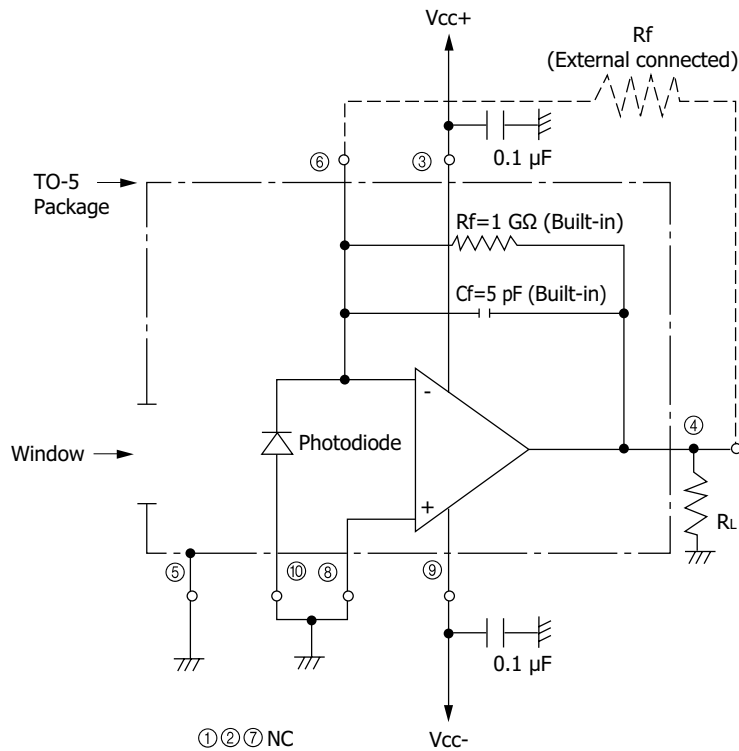

R_L is the input impedance to the next-stage circuit when viewed from the OUT terminal.

KSPDC0048EB

S8746-01

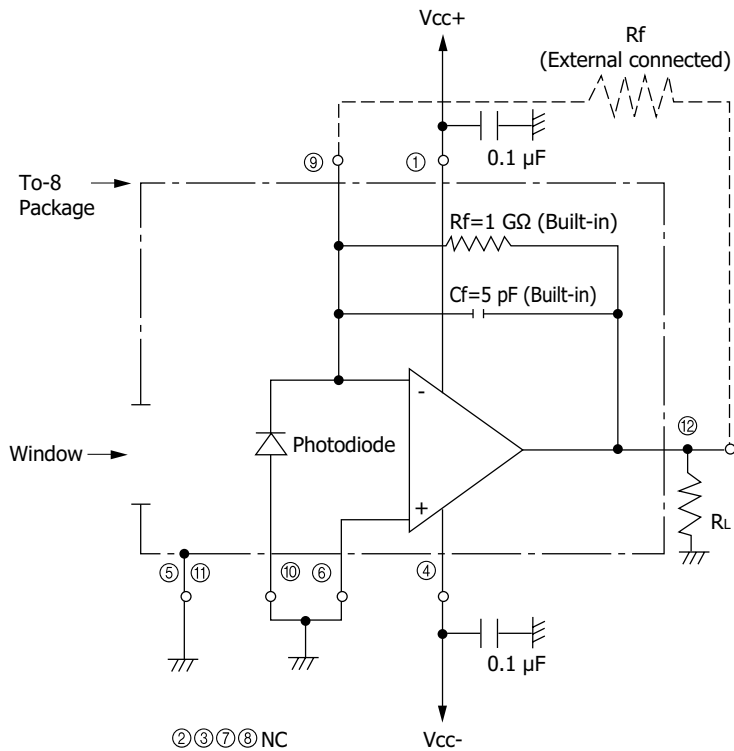

R_L is the input impedance to the next-stage circuit when viewed from the OUT terminal.

KSPDC0049EB

The S8745-01/-06 and S8746-01 use a package with the guard ring effect provided. To make it effective during measurement, the package leads (pin 5 for the S8745-01/-06; pins 5 and 11 for the S8746-01) should be connected to the ground line. When a feedback resistor is externally connected, it is necessary to provide a guard ring on the circuit board or to provide a teflon standoff for the leads.

Note: A tantalum or ceramic capacitor of 0.1 to 10 μ F must be connected to the supply voltage leads (pins 3 and 9 for the S8745-01/-06; pins 1 and 4 for the S8746-01) as a bypass capacitor used to prevent the device from oscillation.

[Figure 6] Dimensional outlines (unit: mm)

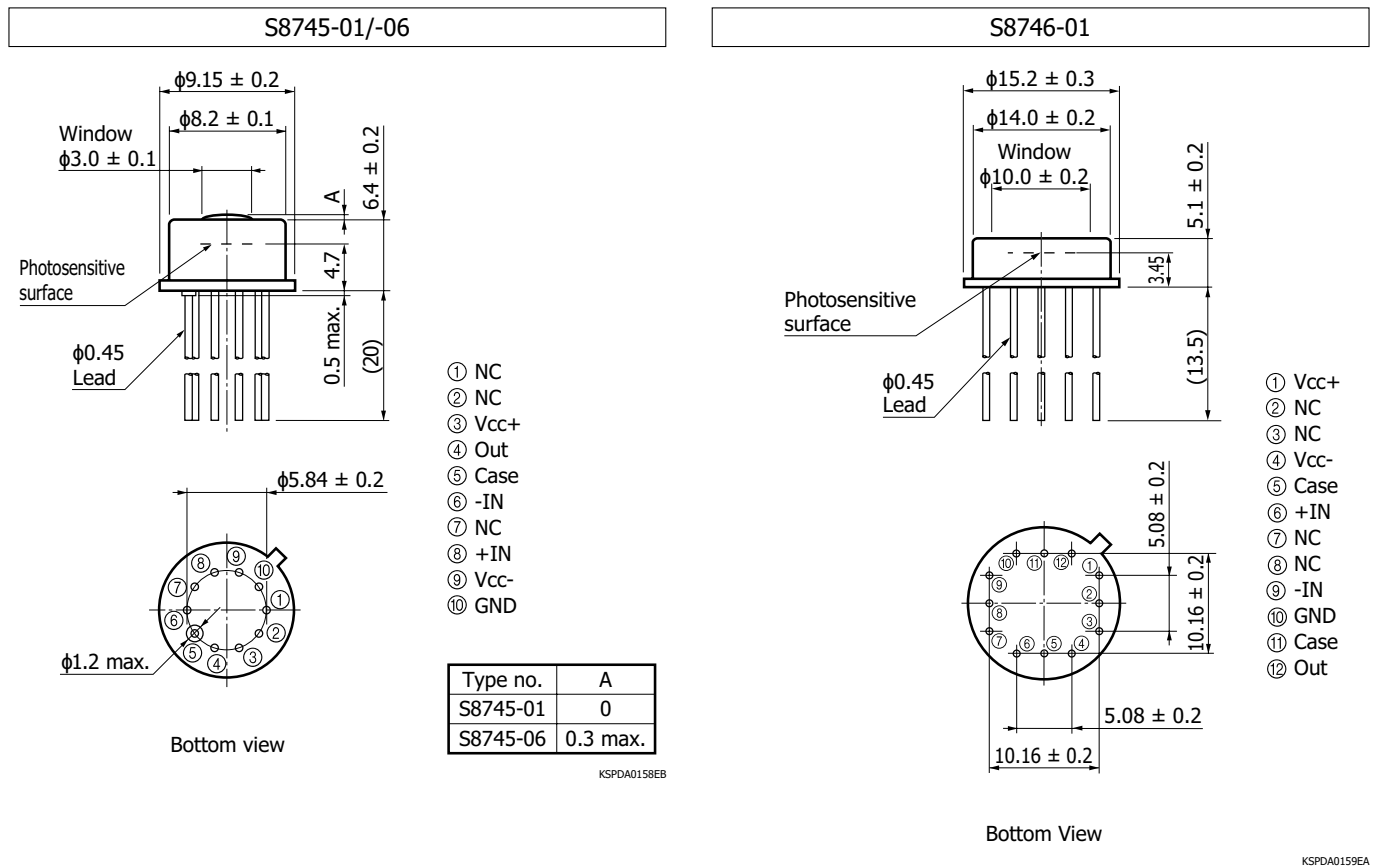

⚠ Precautions

■ ESD

The S8745-01/-06 and S8746-01 may be damaged or their performance may deteriorate by such factors as electro static discharge from the human body, surge voltages from measurement equipment, leakage voltages from soldering irons and packing materials. As a countermeasure against electro static discharge, the device, operator, work place and measuring jigs must all be set at the same potential. The following precautions must be observed during use:

- To protect the device from electro static discharge which accumulate on the operator or the operator's clothes, use a wrist strap or similar tools to ground the operator's body via a high impedance resistor (1 MΩ).
- A semiconductive sheet (1 MΩ to 100 MΩ) should be laid on both the work table and the floor in the work area.
- When soldering, use an electrically grounded soldering iron with an isolation resistance of more than 10 MΩ.
- For containers and packing, use of a conductive material or aluminum foil is effective. When using an antistatic material, use one with a resistance of 0.1 MΩ/cm² to 1 GΩ/cm².

■ Wiring

If electric current or voltage is applied in reverse polarity to an electronic device such as a preamplifier, this can degrade device performance or destroy the device. Always check the wiring and dimensional outline to avoid misconnection.

■ Against UV light exposure

- When UV light irradiation is applied, the product characteristics may degrade. Such examples include degradation of the product's UV sensitivity and increase in dark current. This phenomenon varies depending on the irradiation level, irradiation intensity, usage time, and ambient environment and also varies depending on the product model. Before employing the product, we recommend that you check the tolerance under the ultraviolet light environment that the product will be used in.
- Exposure to UV light may cause the characteristics to degrade due to gas released from the resin bonding the product's component materials. As such, we recommend that you avoid applying UV light directly on the resin and apply it on only the inside of the photosensitive area by using an aperture or the like.

⚠ Related information

http://www.hamamatsu.com/sp/ssd/doc_en.html

■ Precautions

- Disclaimer
- Metal, ceramic, plastic package products

■ Technical information

- Si photodiodes / Technical note

Information described in this material is current as of May 2022.

Product specifications are subject to change without prior notice due to improvements or other reasons. This document has been carefully prepared and the information contained is believed to be accurate. In rare cases, however, there may be inaccuracies such as text errors. Before using these products, always contact us for the delivery specification sheet to check the latest specifications.

The product warranty is valid for one year after delivery and is limited to product repair or replacement for defects discovered and reported to us within that one year period. However, even if within the warranty period we accept absolutely no liability for any loss caused by natural disasters or improper product use. Copying or reprinting the contents described in this material in whole or in part is prohibited without our prior permission.

HAMAMATSU

www.hamamatsu.com

HAMAMATSU PHOTONICS K.K., Solid State Division

1126-1 Ichino-cho, Higashi-ku, Hamamatsu City, 435-8558 Japan, Telephone: (81)53-434-3311, Fax: (81)53-434-5184

U.S.A.: HAMAMATSU CORPORATION: 360 Foothill Road, Bridgewater, NJ 08807, U.S.A., Telephone: (1)908-231-0960, Fax: (1)908-231-1218 E-mail: usa@hamamatsu.com

Germany: HAMAMATSU PHOTONICS DEUTSCHLAND GMBH.: Arzbergerstr. 10, 82211 Herrsching am Ammersee, Germany, Telephone: (49)8152-375-0, Fax: (49)8152-265-8 E-mail: info@hamamatsu.de

France: HAMAMATSU PHOTONICS FRANCE S.A.R.L.: 19, Rue du Saule Trapu, Parc du Moulin de Massy, 91882 Massy Cedex, France, Telephone: (33)1 69 53 71 00, Fax: (33)1 69 53 71 10 E-mail: infos@hamamatsu.fr

United Kingdom: HAMAMATSU PHOTONICS UK LIMITED: 2 Howard Court, 10 Tewin Road, Welwyn Garden City, Hertfordshire AL7 1BW, UK, Telephone: (44)1707-294888, Fax: (44)1707-325777 E-mail: info@hamamatsu.co.uk

North Europe: HAMAMATSU PHOTONICS NORDEN AB: Torshamnsgatan 35 16440 Kista, Sweden, Telephone: (46)8-509 031 00, Fax: (46)8-509 031 01 E-mail: info@hamamatsu.se

Italy: HAMAMATSU PHOTONICS ITALIA S.R.L.: Strada della Moia, 1 int. 6, 20044 Arese (Milano), Italy, Telephone: (39)02-93 58 17 33, Fax: (39)02-93 58 17 41 E-mail: info@hamamatsu.it

China: HAMAMATSU PHOTONICS (CHINA) CO., LTD.: 1201 Tower B, Jianning Center, 27 Dongsanhuan Beilu, Chaoyang District, 100020 Beijing, P.R. China, Telephone: (86)10-6586-6006, Fax: (86)10-6586-2866 E-mail: hpc@hamamatsu.com.cn

Taiwan: HAMAMATSU PHOTONICS TAIWAN CO., LTD.: 8F-3, No.158, Section 2, Gongdao 5th Road, East District, Hsinchu, 300, Taiwan R.O.C. Telephone: (886)3-659-0080, Fax: (886)3-659-0081 E-mail: info@hamamatsu.com.tw