

MEMS-FPI spectrum sensor



C13272-02

Ultra-compact near infrared spectrum sensor that integrates MEMS-FPI tunable filter and photosensor

The MEMS-FPI spectrum sensor S13272-02 is a ultra-compact sensor that houses a MEMS-FPI (Fabry-Perot Interferometer) tunable filter that can vary its transmission wavelength depending on the applied voltage and InGaAs PIN photodiode in a single package. The spectral response range is 1550 to 1850 nm. It is suitable for installation in simple, compact instruments for measuring material absorbance and the like.

Features

- ➔ Built-in Hamamatsu InGaAs PIN photodiode single element chip
- ➔ Spectral response range: 1550 to 1850 nm
- ➔ Ultra-compact: TO-5 package
- ➔ Ultra light: 1 g
- ➔ Hermetically sealed package: High reliability in high humidity environment
- ➔ Built-in thermistor
- ➔ Built-in band-pass filter for cutting off wavelengths outside the spectral response range

Applications

- ➔ Screening of plastic, solutions, and the like
- ➔ Installation into mobile measuring devices

Lineup of MEMS-FPI spectrum sensors

Type no.	Spectral response range	Spectral resolution (FWHM)
	Typ. (nm)	Max. (nm)
C14272	1350 to 1650	18
C13272-02/-03	1550 to 1850	20
C14273	1750 to 2150	22

Peak transmission wavelength vs. filter control voltage (typical example)

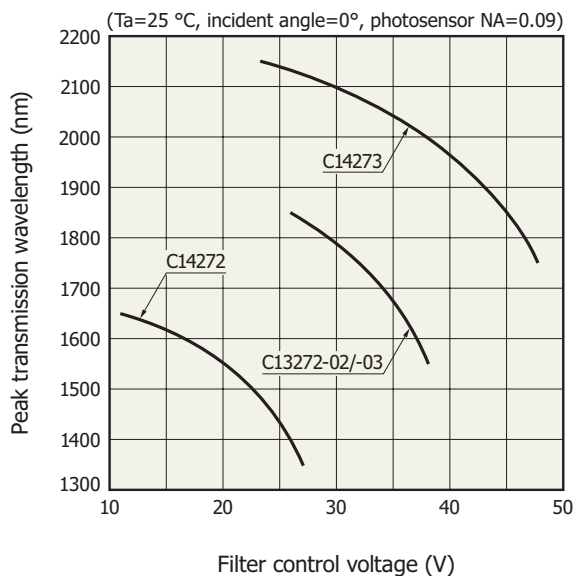

KACCB0482EC

▣ Absolute maximum ratings (Ta=25 °C unless otherwise noted)

Parameter	Symbol	Condition	Value	Unit
Filter control voltage*1	-		$V_{\lambda 1550\text{nm}} + 0.5$	V
Photosensor reverse voltage	V_R		1	V
Photosensor forward current	I_F		10	mA
Operating temperature*2	T_{opr}		-40 to +85	°C
Storage temperature*2	T_{stg}		-40 to +125	°C
Recommended soldering conditions	-		260 °C or less, within 10 s	-
Electrostatic withstand voltage*3	-	Terminals other than photosensor terminals	500	V(HBM)*4
		Between the anode and cathode of the photosensor	100	

*1: Applying a voltage that is +0.5 V or higher than $V_{\lambda 1550\text{nm}}$ (filter control voltage to transmit light at $\lambda=1550$ nm) at a specific temperature may damage the MEMS-FPI tunable filter. For $V_{\lambda 1550\text{nm}}$ of individual products at $T_a=25^\circ\text{C}$, see the final inspection sheet.

*2: No condensation

When there is a temperature difference between a product and the surrounding area in high humidity environment, dew condensation may occur on the product surface. Dew condensation on the product may cause deterioration in characteristics and reliability.

*3: This product is an electrostatic sensitive device. When handling the product, precautions need to be taken to avoid damage and deterioration due to static electricity. For details, refer to the instruction manual supplied with the product.

*4: Human body model

Note: Exceeding the absolute maximum ratings even momentarily may cause a drop in product quality. Always be sure to use the product within the absolute maximum ratings.

▣ Electrical and optical characteristics of MEMS-FPI spectrum sensor (Ta=25 °C, unless otherwise noted)

Parameter	Symbol	Min.	Typ.	Max.	Unit
Spectral response range	λ	1550 to 1850			nm
Spectral resolution (FWHM)*5	-	-	-	20	nm
Wavelength temperature dependence*6	-	-	0.4	-	nm/°C
Wavelength reproducibility*7	-	-	± 2	-	nm
Settling time (0 V → $V_{\lambda 1550\text{nm}}$)*8	-	-	1	-	ms
Dark current*9	I_D	-	4	40	nA
Thermistor resistance	-	9.6	10	10.4	k Ω

*5: Incident angle=0°, photosensor NA=0.09

*6: $\lambda=1700$ nm

*7: When filter control voltage, incident light condition, and usage environment, etc. are constant

*8: Time for the output signal to reach 99% of the stable signal level when the control voltage of the MEMS-FPI tunable filter is varied from 0 V to $V_{\lambda 1550\text{nm}}$

*9: $V_R=0.5$ V

▣ Electrical and optical characteristics of built-in InGaAs PIN photodiode (Ta=25 °C unless otherwise noted)

Parameter	Symbol	Condition	Min.	Typ.	Max.	Unit
Photosensitive area	A		$\phi 0.1$			mm
Spectral response range	λ		900 to 2100			nm
Peak sensitivity wavelength	λ_p		1800	1950	2050	nm
Photosensitivity	S	$\lambda=\lambda_p$	1.0	1.2	-	A/W
Detectivity	D^*	$\lambda=\lambda_p$	9×10^{10}	2.5×10^{11}	-	$\text{cm} \cdot \text{Hz}^{1/2}/\text{W}$
Noise equivalent power	NEP	$\lambda=\lambda_p$	-	4×10^{-14}	9×10^{-14}	$\text{W}/\text{Hz}^{1/2}$
Terminal capacitance	C_t	$V_R=0$ V, $f=1$ MHz	-	8	20	pF

Temperature characteristics of $V_{\lambda 1550\text{nm}}$ (typical example)

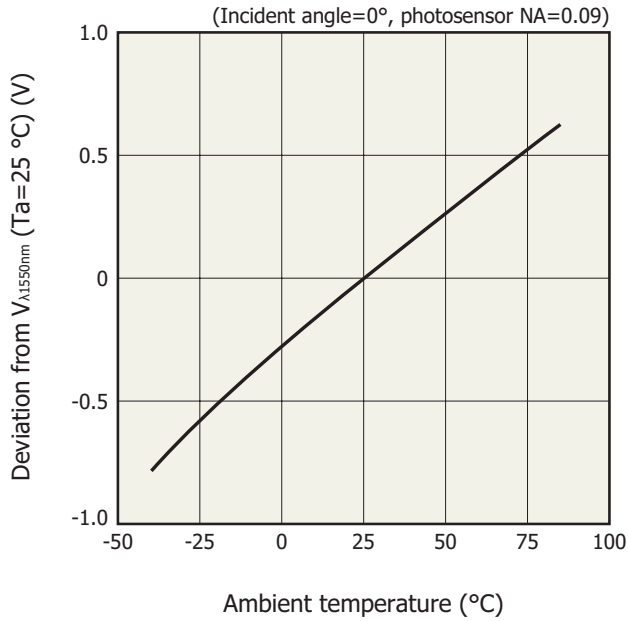

Spectral resolution vs. peak transmission wavelength (typical example)

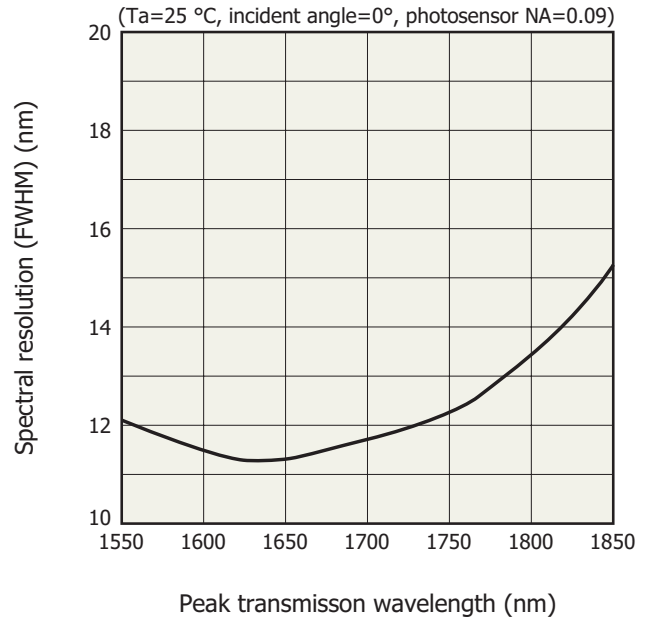

Peak transmission wavelength vs. ambient temperature (typical example)

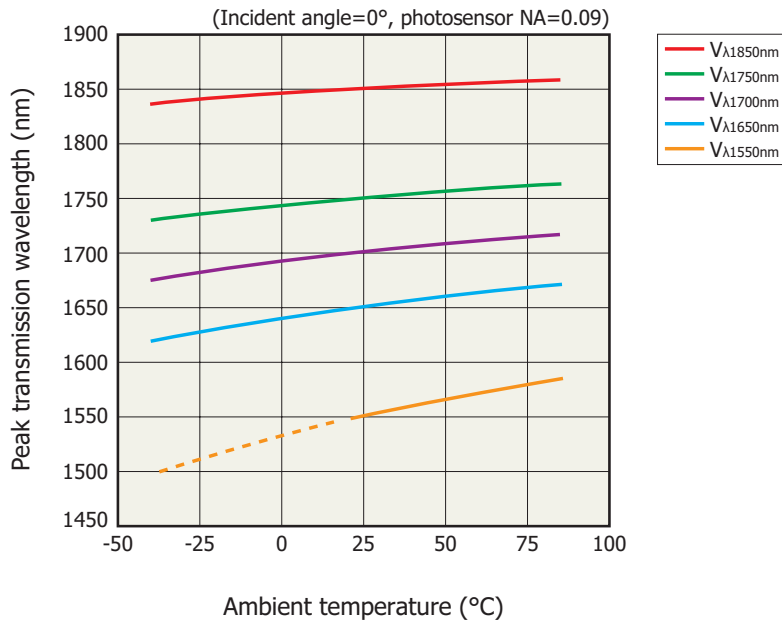

The broken line corresponds to data when the built-in band-pass filter is removed. The C13272-02 cannot detect the peak transmission wavelength accurately in this range. This is because when the ambient temperature is less than 25 °C, the peak transmission wavelength of the MEMS-FPI tunable filter is outside the transmission wavelength range of the band-pass filter.

Filter control voltage vs. ambient temperature (typical example)

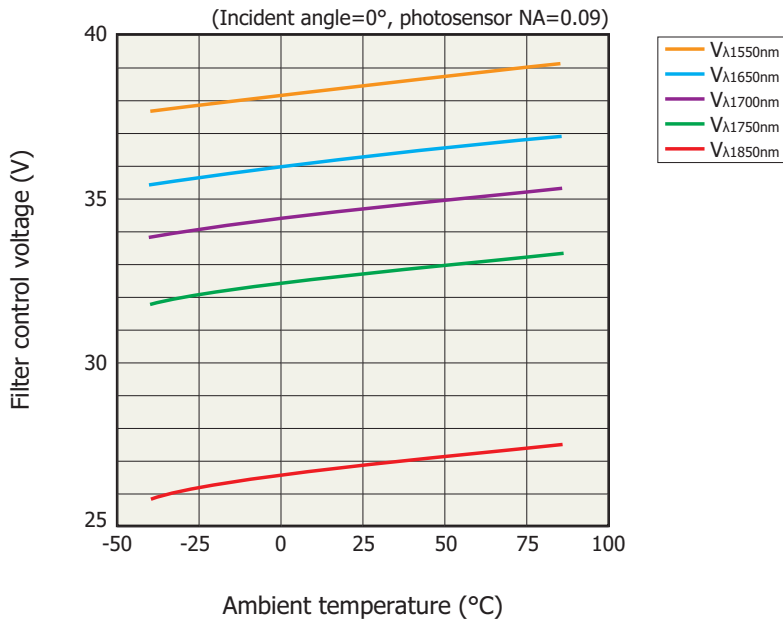

KACCB0432EB

Spectral transmittance characteristics of band-pass filter (typical example)

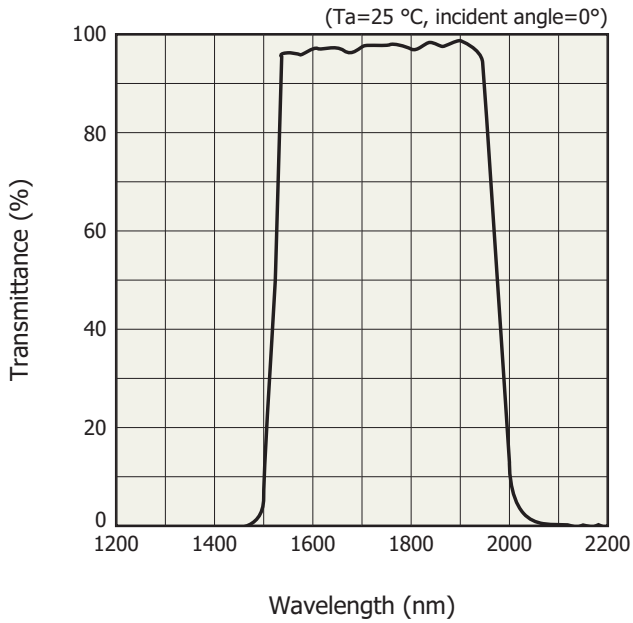

KACCB0433EB

Thermistor resistance vs. temperature (typical example)

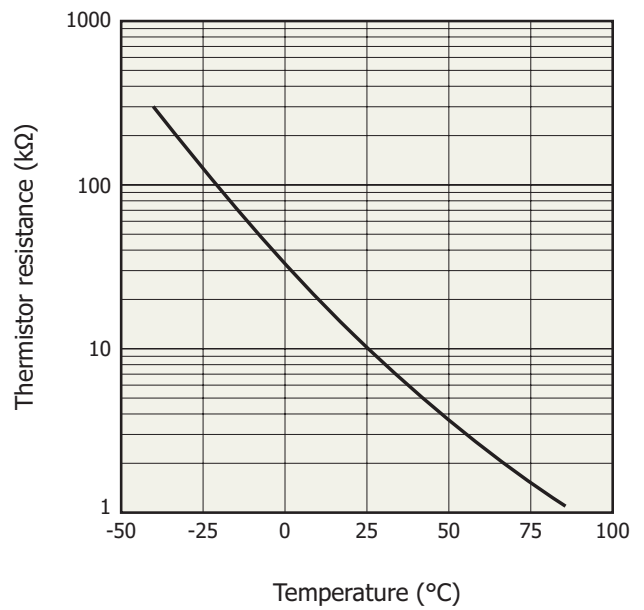

KACCB0404EB

Transmittance of MEMS-FPI tunable filter vs. wavelength (typical example)

[$T_a=25\text{ }^\circ\text{C}$, input line spectrum, line spectrum resolution (FWHM)= 3 nm max.,
incident angle= 0° , photosensor NA=0.09]

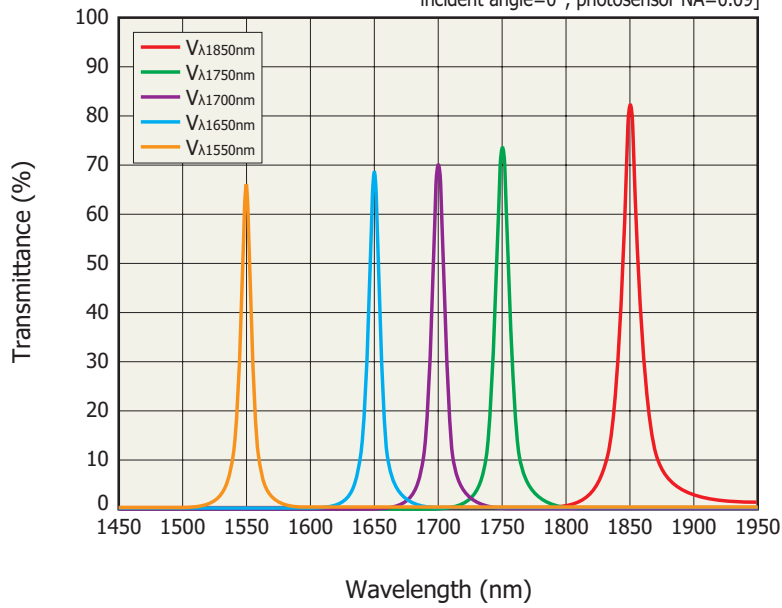

- There is tolerance in filter control voltage for arbitrary peak transmission wavelength from unit to unit. The individual data for $V_{\lambda 1850\text{nm}}$ and $V_{\lambda 1550\text{nm}}$ at $T_a=25\text{ }^\circ\text{C}$ is to be described in an inspection sheet attached with a product on delivery.

KACCB0405EA

Dimensional outline (unit: mm)

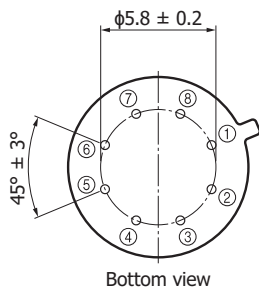
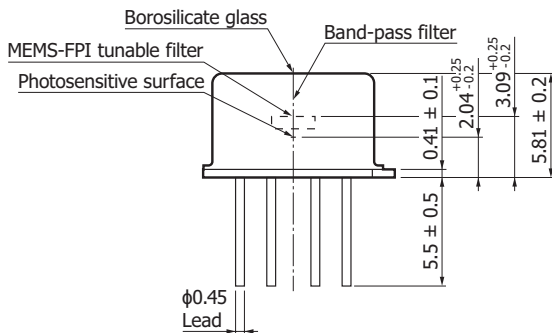
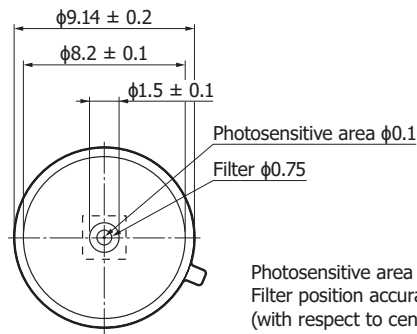

①	CASE
②	LOW-MIR
③	NTC-2
④	NTC-1
⑤	UP-MIR
⑥	CASE
⑦	InGaAs-Anode
⑧	InGaAs-Cathode

KACCA0385ED

Pin connections

Pin no.	Name	Input/Output	Description
1	CASE	-	Case connection
2	LOW-MIR	Input	MEMS-FPI tunable filter lower electrode
3	NTC-2	Output	For thermistor
4	NTC-1	Output	For thermistor
5	UP-MIR	Input	MEMS-FPI tunable filter upper electrode
6	CASE	-	Case connection
7	InGaAs-Anode	Output	
8	InGaAs-Cathode	Output	

Marking information

Marking item	Description
DataMatrix	Shape: rectangle Cell size: 0.14 × 0.14 mm Symbol size: 12 × 26 cell Input information example: C13272-02, ***** ("Type no." + "," + "Serial no.")
C13272-02	Type no.
*****	Serial no. *: information on year and month #####: number of five digits (number of individual product)

Marking example on cap

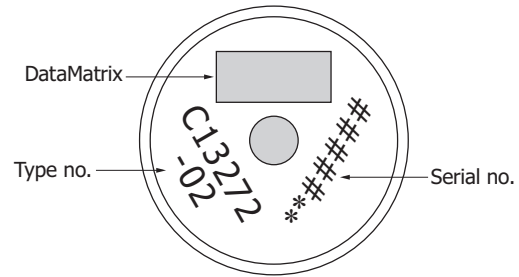

KACCC0837EB

Note: KEYENCE CORPORATION code reader SR-1000 is recommended for reading the DataMatrix.

Connection example

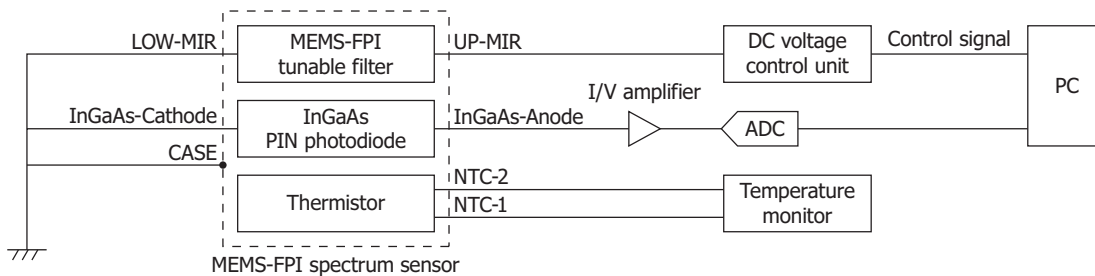

KACCC0804EA

MEMS-FPI spectrum sensor structure

The MEMS-FPI spectrum sensor is composed of a MEMS-FPI tunable filter, photosensor (photodiode), and the like. It has a simple structure in which a MEMS-FPI tunable filter and photosensor is arranged on the same axis as the direction of the incident light. Though this product is a spectrum sensor, it uses a single-element photosensor and does not require an expensive multichannel photosensor.

Internal structure

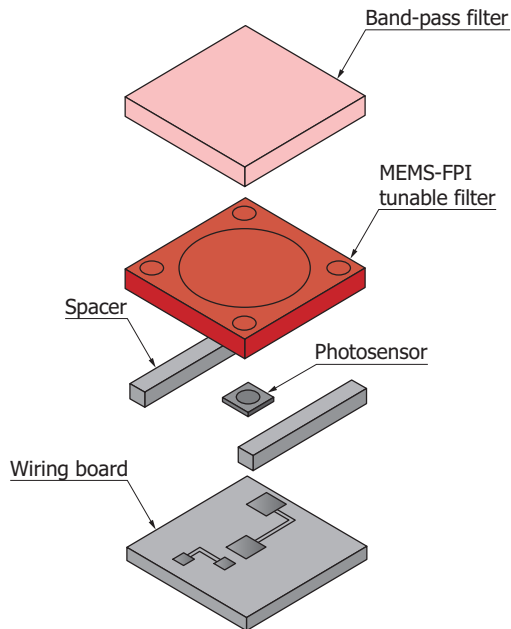

KIRDC0108EC

MEMS-FPI tunable filter

The MEMS-FPI tunable filter has an upper mirror and a lower mirror that are placed opposite each other with an air gap in between them. When a voltage is applied across the mirrors, an electrostatic attractive force is produced to adjust the air gap. To facilitate this action, the upper mirror has a membrane (thin film) structure. If the air gap is $m\lambda/2$ (m : integer), it functions as a filter that allows wavelengths near λ to pass through. When the filter control voltage is increased, the air gap is narrowed by the electrostatic attractive force, and the transmission peak wavelength shifts to the short-wavelength side.

MEMS-FPI tunable filter cross section

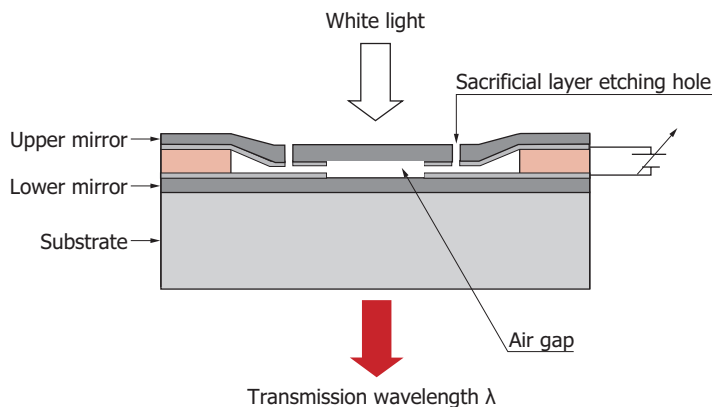

KIRDC0109EA

▣ Spectral response (typical example)

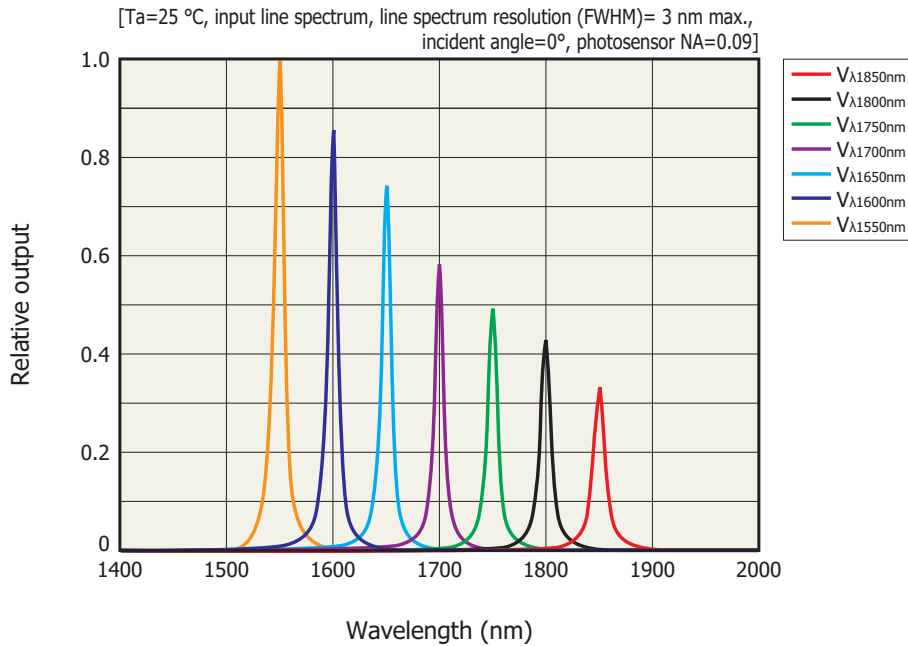

KACCB0434ED

▣ Precautions

Note the following when handling the product and also after installing into a device.

■ Handling

- When touching the product, it is recommended to wear gloves or use tweezers. Touching the product with bare hands may cause degradation in characteristics and plating corrosion and may lead to problems with solder wettability.
- Perform work in a clean place.

■ Filter control voltage

- Apply filter control voltage as defined by the absolute maximum ratings. Applying a filter control voltage exceeding the absolute maximum ratings may damage the MEMS-FPI tunable filter.

■ Static electricity

- The MEMS-FPI spectrum sensor is an electrostatic sensitive device. When handling the product, precautions need to be taken to avoid damage and deterioration due to static electricity. For details, refer to the instruction manual supplied with the product.

Related product

Spectroscopic modules C15712, C15713, C15714



These are compact modules with built-in MEMS-FPI spectroscopic sensors, light sources, and control circuits. Since they come with evaluation software that has functions such as setting measurement conditions, data acquisition and storage, and graph display, spectrum and absorbance can be easily measured by connecting to a PC via USB. It can also be used to characterize MEMS-FPI spectroscopic sensors C14272, C13272-03, and C14273.

Type no.	Built-in MEMS-FPI spectrum sensor	Spectral response range
C15712	C14272	1350 to 1650 nm
C15713	C13272-03	1550 to 1850 nm
C15714	C14273	1750 to 2150 nm

Related information

www.hamamatsu.com/sp/ssd/doc_en.html

Precautions

- Disclaimer
- Safety consideration
- Compound opto-semiconductors (photosensors, light emitters)

Technical information

- MEMS-FPI spectrum sensors, spectroscopic modules
- Compound semiconductor photosensors

Information described in this material is current as of June 2022.

Product specifications are subject to change without prior notice due to improvements or other reasons. This document has been carefully prepared and the information contained is believed to be accurate. In rare cases, however, there may be inaccuracies such as text errors. Before using these products, always contact us for the delivery specification sheet to check the latest specifications.

The product warranty is valid for one year after delivery and is limited to product repair or replacement for defects discovered and reported to us within that one year period. However, even if within the warranty period we accept absolutely no liability for any loss caused by natural disasters or improper product use. Copying or reprinting the contents described in this material in whole or in part is prohibited without our prior permission.

HAMAMATSU

www.hamamatsu.com

HAMAMATSU PHOTONICS K.K., Solid State Division

1126-1 Ichino-cho, Higashi-ku, Hamamatsu City, 435-8558 Japan, Telephone: (81)53-434-3311, Fax: (81)53-434-5184

U.S.A.: HAMAMATSU CORPORATION: 360 Foothill Road, Bridgewater, NJ 08807, U.S.A., Telephone: (1)908-231-0960, Fax: (1)908-231-1218 E-mail: usa@hamamatsu.com

Germany: HAMAMATSU PHOTONICS DEUTSCHLAND GMBH.: Arzbergerstr. 10, 82211 Herrsching am Ammersee, Germany, Telephone: (49)8152-375-0, Fax: (49)8152-265-8 E-mail: info@hamamatsu.de

France: HAMAMATSU PHOTONICS FRANCE S.A.R.L.: 19, Rue du Saule Trapu, Parc du Moulin de Massy, 91882 Massy Cedex, France, Telephone: (33)1 69 53 71 00, Fax: (33)1 69 53 71 10 E-mail: infos@hamamatsu.fr

United Kingdom: HAMAMATSU PHOTONICS UK LIMITED: 2 Howard Court, 10 Tewin Road, Welwyn Garden City, Hertfordshire AL7 1BW, UK, Telephone: (44)1707-294888, Fax: (44)1707-325777 E-mail: info@hamamatsu.co.uk

North Europe: HAMAMATSU PHOTONICS NORDEN AB: Torshamnsgatan 35 16440 Kista, Sweden, Telephone: (46)8-509 031 00, Fax: (46)8-509 031 01 E-mail: info@hamamatsu.se

Italy: HAMAMATSU PHOTONICS ITALIA S.R.L.: Strada della Moia, 1 int. 6, 20044 Arese (Milano), Italy, Telephone: (39)02-93 58 17 33, Fax: (39)02-93 58 17 41 E-mail: info@hamamatsu.it

China: HAMAMATSU PHOTONICS (CHINA) CO., LTD.: 1201 Tower B, Jianning Center, 27 Dongsanhuan Beilu, Chaoyang District, 100020 Beijing, P.R. China, Telephone: (86)10-6586-6006, Fax: (86)10-6586-2866 E-mail: hpc@hamamatsu.com.cn

Taiwan: HAMAMATSU PHOTONICS TAIWAN CO., LTD.: 8F-3, No.158, Section 2, Gongdao 5th Road, East District, Hsinchu, 300, Taiwan R.O.C. Telephone: (886)3-659-0080, Fax: (886)3-659-0081 E-mail: info@hamamatsu.com.tw