

InGaAs APD

G14858-0020AA



InGaAs APD that greatly reduces dark current

This InGaAs APD (avalanche photodiode) greatly reduces dark current over existing products by the use of a new device structure and improved processing. The G14858-0020AA is used for distance measurement, low-light-level detection, and so on.

Features

- Low dark current
- Low capacitance
- High sensitivity

Applications

- Distance measurement
- Low-light-level detection

Structure

Parameter	Specification	Unit
Window material	Borosilicate glass (AR coated: 1.55 μm)	-
Package	TO-18	-
Photosensitive area	φ0.2	mm

Absolute maximum ratings

Parameter	Symbol	Specification	Unit
Reverse current	I_R max	2	mA
Forward current	I_F max	10	mA
Operating temperature*1	T_{opr}	-40 to +85	°C
Storage temperature*1	T_{stg}	-55 to +125	°C

*1: No dew condensation

Note: Exceeding the absolute maximum ratings even momentarily may cause a drop in product quality. Always be sure to use the product within the absolute maximum ratings.

Electrical and optical characteristics (Ta=25 °C)

Parameter	Symbol	Condition	Min.	Typ.	Max.	Unit
Spectral response range	λ		-	0.95 to 1.7	-	μm
Peak sensitivity wavelength	λ_p		-	1.55	-	μm
Photosensitivity	S	$\lambda=1.55 \mu\text{m}, M=1$	0.65	0.8	-	A/W
Dark current	I_D	$V_R=V_{BR} \times 0.95$	-	20	50	nA
Temperature coefficient of dark current	ΔT_{ID}	$V_R=V_{BR} \times 0.95$	-	1.07	-	times/°C
Terminal capacitance	C_t	$V_R=V_{BR} \times 0.95, f=1 \text{ MHz}$	-	2.0	-	pF
Cutoff frequency	f_c	$M=10, R_L=50 \Omega$	-	0.9	-	GHz
Breakdown voltage	V_{BR}	$I_D=100 \mu\text{A}$	50	65	80	V
Temperature coefficient of breakdown voltage	Γ	-40 to +85 °C	-	0.1	-	V/°C
Gain	M	$\lambda=1.55 \mu\text{m}, -30 \text{ dBm}$	-	30	-	-

Note: Attachment data: breakdown voltage ($I_D=100 \mu\text{A}$), dark current ($V_R=V_{BR} \times 0.95$), terminal capacitance ($V_R=V_{BR} \times 0.95, f=1 \text{ MHz}$), dark current vs. reverse voltage (graph), gain vs. reverse voltage (graph)

Spectral response

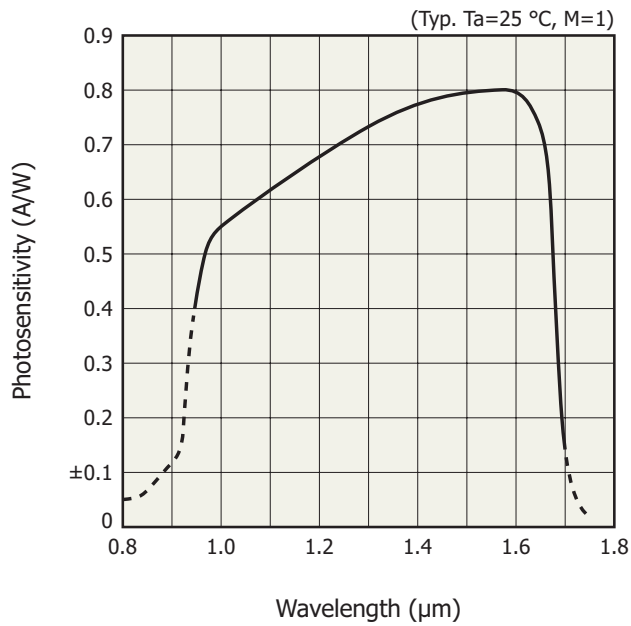

KAPDB0417EA

Spectral transmittance of window material

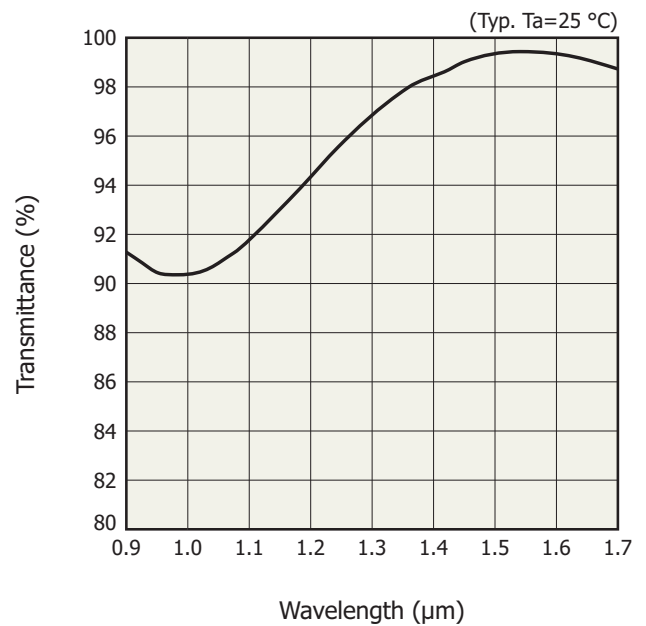

KAPDB0389EA

Photosensitivity temperature characteristics

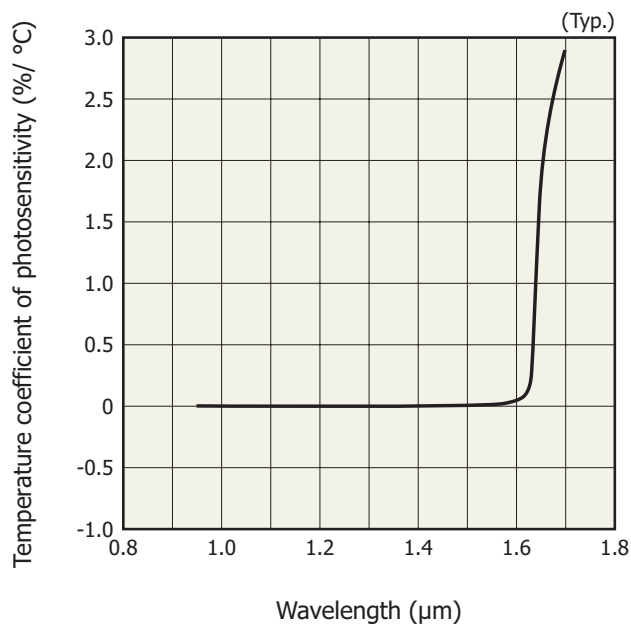

KAPDB0390EA

Terminal capacitance vs. reverse voltage

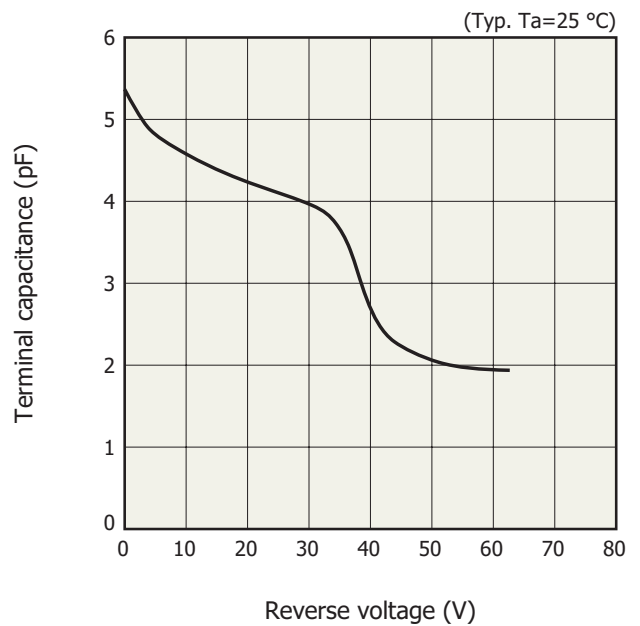

KAPDB0418EA

Dark current, photocurrent, gain vs. reverse voltage

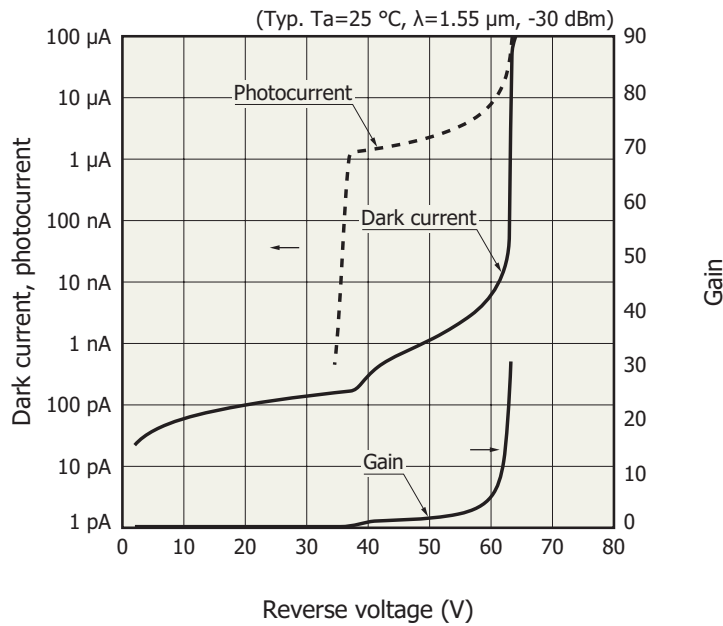

KAPD80423EA

Dimensional outline (unit: mm)

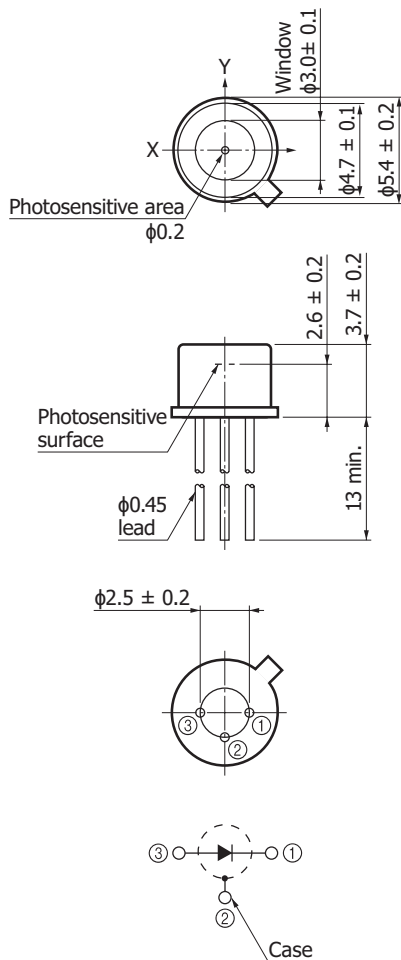

KAPDA0192EA

APD peripheral circuit example

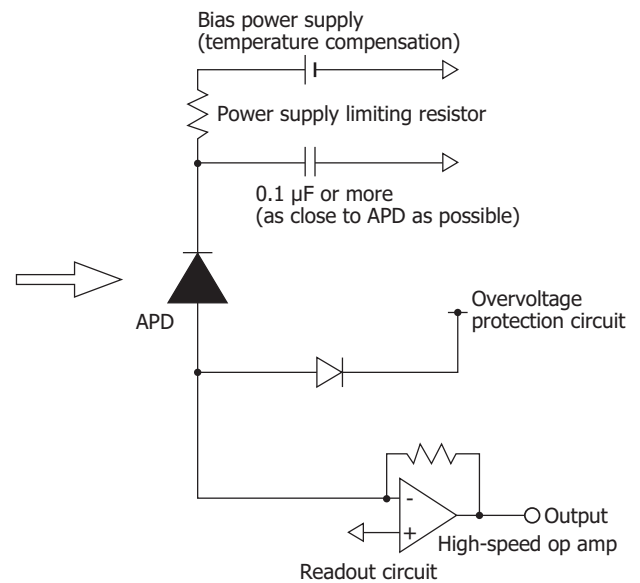

KAPDC0005EC

Related information

www.hamamatsu.com/sp/ssd/doc_ja.html

■ Precautions

- Disclaimer
- Safety consideration
- Metal, ceramic, plastic package products

Information described in this material is current as of January 2019.

Product specifications are subject to change without prior notice due to improvements or other reasons. This document has been carefully prepared and the information contained is believed to be accurate. In rare cases, however, there may be inaccuracies such as text errors. Before using these products, always contact us for the delivery specification sheet to check the latest specifications.

The product warranty is valid for one year after delivery and is limited to product repair or replacement for defects discovered and reported to us within that one year period. However, even if within the warranty period we accept absolutely no liability for any loss caused by natural disasters or improper product use. Copying or reprinting the contents described in this material in whole or in part is prohibited without our prior permission.

HAMAMATSU

www.hamamatsu.com

HAMAMATSU PHOTONICS K.K., Solid State Division

1126-1 Ichino-cho, Higashi-ku, Hamamatsu City, 435-8558 Japan, Telephone: (81)53-434-3311, Fax: (81)53-434-5184

U.S.A.: Hamamatsu Corporation: 360 Foothill Road, Bridgewater, N.J. 08807, U.S.A., Telephone: (1)908-231-0960, Fax: (1)908-231-1218, E-mail: usa@hamamatsu.com

Germany: Hamamatsu Photonics Deutschland GmbH: Arzbergerstr. 10, D-82211 Herrsching am Ammersee, Germany, Telephone: (49)8152-375-0, Fax: (49)8152-265-8, E-mail: info@hamamatsu.de

France: Hamamatsu Photonics France S.A.R.L.: 19, Rue du Saule Trapu, Parc du Moulin de Massy, 91882 Massy Cedex, France, Telephone: (33)1 69 53 71 00, Fax: (33)1 69 53 71 10, E-mail: infos@hamamatsu.fr

United Kingdom: Hamamatsu Photonics UK Limited: 2 Howard Court, 10 Tewin Road, Welwyn Garden City, Hertfordshire AL7 1BW, United Kingdom, Telephone: (44)1707-294888, Fax: (44)1707-325777, E-mail: info@hamamatsu.co.uk

North Europe: Hamamatsu Photonics Norden AB: Torshamnsgatan 35 16440 Kista, Sweden, Telephone: (46)8-509 031 00, Fax: (46)8-509 031 01, E-mail: info@hamamatsu.se

Italy: Hamamatsu Photonics Italia S.r.l.: Strada della Moia, 1 int. 6, 20020 Arese (Milano), Italy, Telephone: (39)02-93 58 17 33, Fax: (39)02-93 58 17 41, E-mail: info@hamamatsu.it

China: Hamamatsu Photonics (China) Co., Ltd.: B1201, Jiaming Center, No.27 Dongsanhuan Beilu, Chaoyang District, 100020 Beijing, P.R.China, Telephone: (86)10-6586-6006, Fax: (86)10-6586-2866, E-mail: hpc@hamamatsu.com.cn

Taiwan: Hamamatsu Photonics Taiwan Co., Ltd.: 8F-3, No. 158, Section2, Gongdao 5th Road, East District, Hsinchu, 300, Taiwan R.O.C. Telephone: (886)3-659-0080, Fax: (886)3-659-0081, E-mail: info@hamamatsu.com.tw