

# One-dimensional PSD

S15430 series

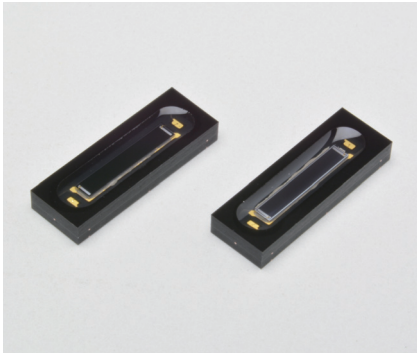

## PSD compatible to lead-free reflow soldering

The S15430 series is a position sensitive detector (PSD) compatible to lead-free reflow soldering. The small and thin leadless package allows reducing the mount area on a printed circuit board.

### Features

- Photosensitive area: 1 × 6 mm (resistance length: 6 mm)
- Visible light cut type (S15430-01CT, S15430-03CT)
- High interelectrode resistance: 300 kΩ (S15430-03CT)
- Surface mount type  
Compact and thin leadless package
- Applicable lead-free reflow soldering

### Applications

- Distance measuring equipment
- Camera auto-focus
- Proximity switches
- Displacement meters

### Structure

Parameter	Specification	Unit
Photosensitive area	1 × 6	mm
Package	Glass epoxy	-
Sealing material	Silicone resin	-

### Absolute maximum ratings

Parameter	Symbol	Condition	Value	Unit
Reverse voltage	V <sub>R max</sub>	T <sub>a</sub> =25 °C	10	V
Operating temperature	T <sub>opr</sub>	No dew condensation*1	-25 to 85	°C
Storage temperature	T <sub>stg</sub>	No dew condensation*1	-40 to 100	°C
Soldering temperature*2	T <sub>sol</sub>		250 (twice)	°C

\*1: When there is a temperature difference between a product and the surrounding area in high humidity environment, dew condensation may occur on the product surface. Dew condensation on the product may cause deterioration in characteristics and reliability.

\*2: Reflow soldering, IPC/JEDEC J-STD-020 MSL 3, see P.6

Note: Exceeding the absolute maximum ratings even momentarily may cause a drop in product quality. Always be sure to use the product within the absolute maximum ratings.

Electrical and optical characteristics (Ta=25 °C)

Parameter	Symbol	Condition	S15430-01CT			S15430-02CT			S15430-03CT			Unit
			Min.	Typ.	Max.	Min.	Typ.	Max.	Min.	Typ.	Max.	
Spectral response range	$\lambda$		-	780 to 1100	-	-	320 to 1100	-	-	780 to 1100	-	nm
Peak sensitivity wavelength	$\lambda_p$		-	960	-	-	960	-	-	960	-	nm
Photosensitivity	S	$\lambda=890$ nm	-	0.5	-	-	0.55	-	-	0.5	-	A/W
Interelectrode resistance	Rie	Vb=0.1 V	30	50	80	30	50	80	240	300	360	k $\Omega$
Position detection error*3	-	VR=1 V Light spot size= $\phi$ 300 $\mu$ m	-	$\pm$ 20	$\pm$ 60	-	$\pm$ 20	$\pm$ 60	-	$\pm$ 20	$\pm$ 60	$\mu$ m
Saturation current*4	Ist	VR=1 V, RL=1 k $\Omega$	80	-	-	80	-	-	20	-	-	$\mu$ A
Dark current	ID	VR=1 V	-	0.1	2	-	0.1	2	-	0.1	2	nA
Dark current temperature coefficient	$\Delta T_{ID}$		-	1.15	-	-	1.15	-	-	1.15	-	times/°C
Rise time*5	tr	VR=1 V, $\lambda=650$ nm	-	-	-	-	2	-	-	-	-	$\mu$ s
		RL=1 k $\Omega$ , $\lambda=890$ nm	-	5	-	-	5	-	-	15	-	
Terminal capacitance	Ct	VR=1 V, f=10 kHz	-	60	90	-	60	90	-	60	90	pF

\*3: In the range 75% from the center of the photosensitive area to the edge

\*4: Upper limit of linearity of the photocurrent relative to the total incident light level. Photocurrent at a point 10% deviation from linearity

\*5: Time required for output change from 10 to 90% of the steady output value when stepped function light is input to the PSD

Spectral response

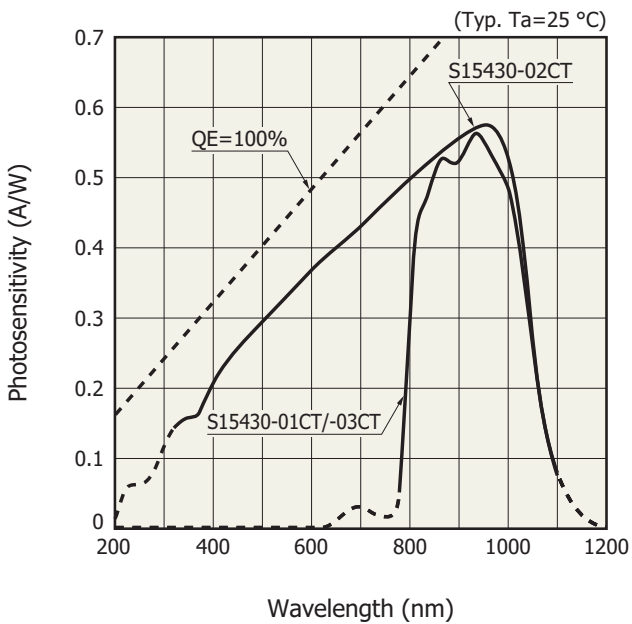

Dark current vs. reverse voltage

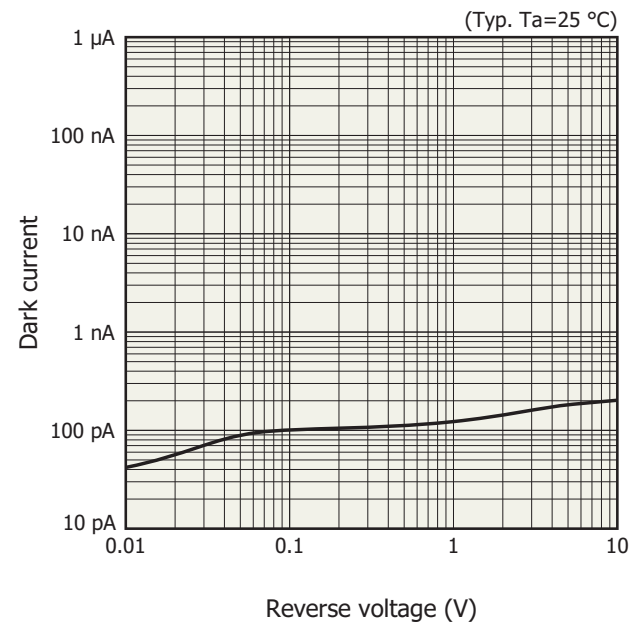

Terminal capacitance vs. reverse voltage

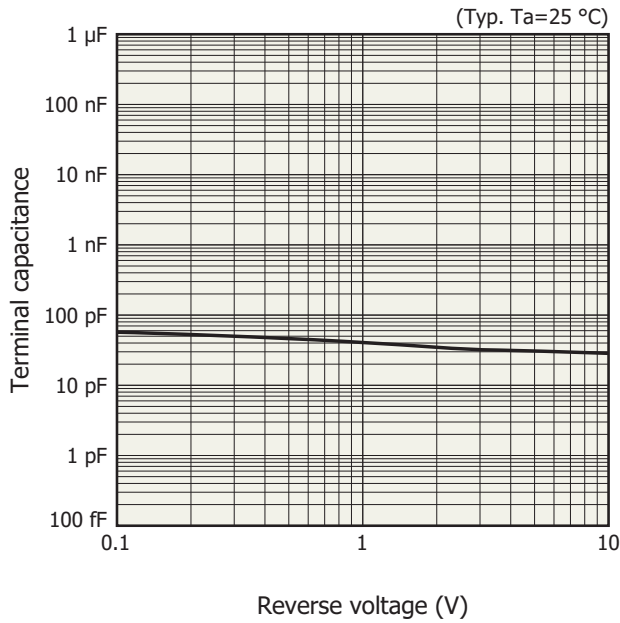

Saturation photocurrent vs. interelectrode resistance

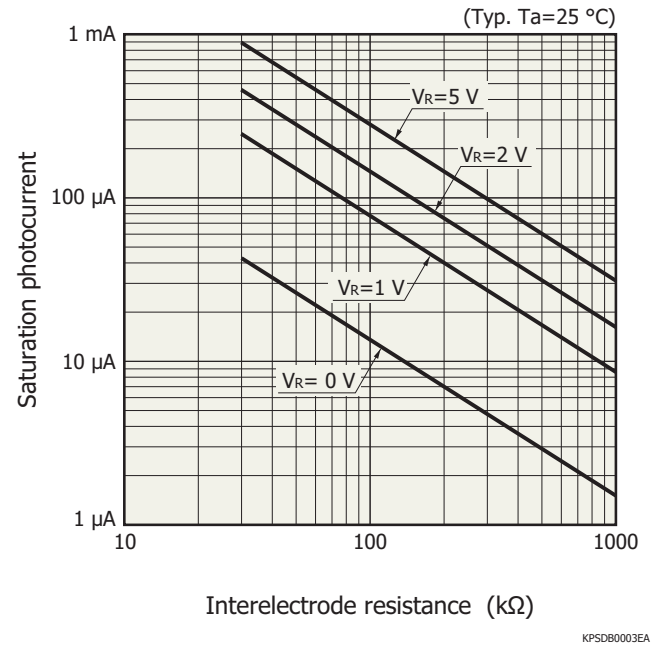

Definition of position detection error

Given the electrical center position to be the incident position that produces  $I_1=I_2$ , the position detection error at each incident position is defined by the following equation.

$$\text{Position detection error } (\mu\text{m}) = \text{Incident position} - \frac{I_2 - I_1}{I_1 + I_2} \times \frac{L}{2}$$

The value at the incident position assumes that the electrical center position is 0 with the  $I_1$  side as negative and  $I_2$  side as positive.

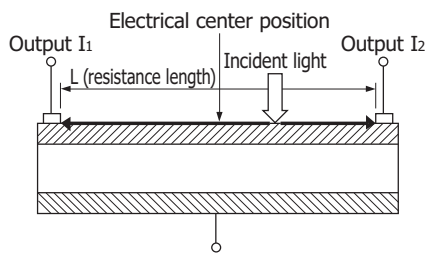

**Dimensional outline (unit: mm)**

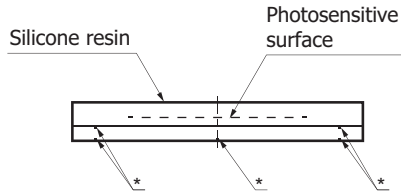
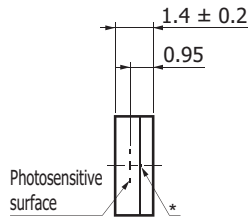
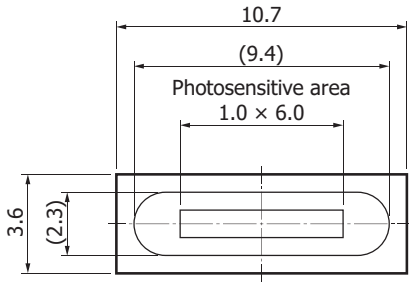

- ① Anode 1
- ② NC
- ③ Cathode (common)
- ④ Anode 2
- ⑤ NC
- ⑥ Cathode (common)

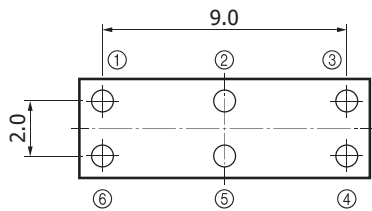

Tolerance unless otherwise noted:  $\pm 0.1$  mm,  $\pm 2^\circ$   
 Values in parentheses indicate reference values.  
 Chip position accuracy with respect to the base edge  
 $X, Y \leq \pm 0.2$ ,  $\theta \leq \pm 2^\circ$   
 \* Do not allow metal/conductive objects to contact the part where the wiring is exposed. Doing so may cause short circuits.  
 (the opposite side is the same)

KPSDA0067EA

**Recommended land pattern (unit: mm)**

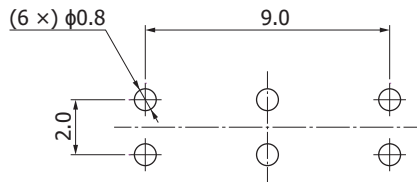

KPSDC0098EA

**Reel packing specifications**

- Reel (conforms to JEITA ET-7200)

Outer diameter	Hub diameter	Tape width	Material	Electrostatic characteristics
φ254 mm	φ100 mm	12 mm	PS	Conductive

- Embossed tape (unit: mm, material: PS, conductive)

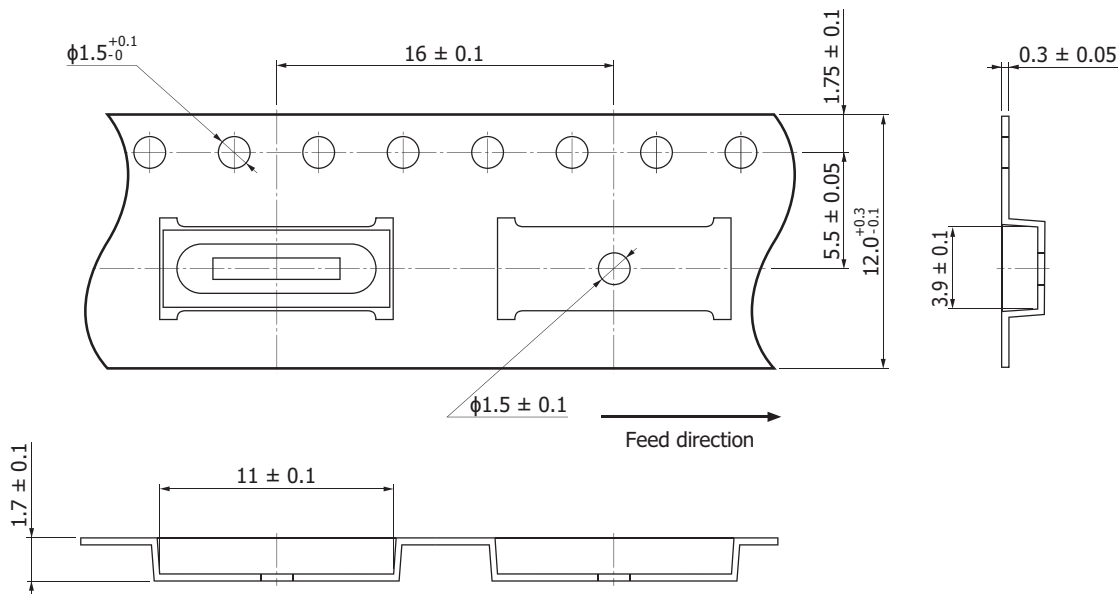

KPSDC0099EA

- Packing quantity  
1000 pcs/reel
- Packing state  
Reel and desiccant in moisture-proof packaging (vacuum-sealed)

### Recommended soldering conditions

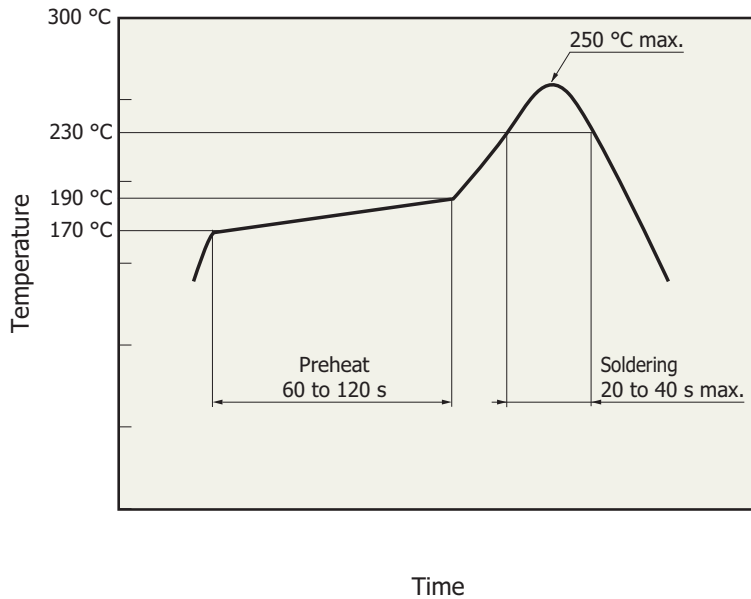

KPSDC0032EA

- This product supports lead-free soldering. After unpacking, store it in an environment at a temperature of 30 °C or less and a humidity of 60% or less, and perform soldering within 168 hours.
- The effect that the product receives during reflow soldering varies depending on the circuit board and reflow oven that are used. When you set reflow soldering conditions, check that problems do not occur in the product by testing out the conditions in advance.

### Related information

[www.hamamatsu.com/sp/ssd/doc\\_en.html](http://www.hamamatsu.com/sp/ssd/doc_en.html)

- Precautions
  - Disclaimer
  - Surface mount type products
- Technical information
  - PSD

Information described in this material is current as of December 2021.

Product specifications are subject to change without prior notice due to improvements or other reasons. This document has been carefully prepared and the information contained is believed to be accurate. In rare cases, however, there may be inaccuracies such as text errors. Before using these products, always contact us for the delivery specification sheet to check the latest specifications.

The product warranty is valid for one year after delivery and is limited to product repair or replacement for defects discovered and reported to us within that one year period. However, even if within the warranty period we accept absolutely no liability for any loss caused by natural disasters or improper product use. Copying or reprinting the contents described in this material in whole or in part is prohibited without our prior permission.

# HAMAMATSU

[www.hamamatsu.com](http://www.hamamatsu.com)

HAMAMATSU PHOTONICS K.K., Solid State Division  
1126-1 Ichino-cho, Higashi-ku, Hamamatsu City, 435-8558 Japan, Telephone: (81)53-434-3311, Fax: (81)53-434-5184

U.S.A.: HAMAMATSU CORPORATION: 360 Foothill Road, Bridgewater, NJ 08807, U.S.A., Telephone: (1)908-231-0960, Fax: (1)908-231-1218 E-mail: [usa@hamamatsu.com](mailto:usa@hamamatsu.com)

Germany: HAMAMATSU PHOTONICS DEUTSCHLAND GMBH.: Arzbergerstr. 10, 82211 Herrsching am Ammersee, Germany, Telephone: (49)8152-375-0, Fax: (49)8152-265-8 E-mail: [info@hamamatsu.de](mailto:info@hamamatsu.de)

France: HAMAMATSU PHOTONICS FRANCE S.A.R.L.: 19, Rue du Saule Trapu, Parc du Moulin de Massy, 91882 Massy Cedex, France, Telephone: (33)1 69 53 71 00, Fax: (33)1 69 53 71 10 E-mail: [infos@hamamatsu.fr](mailto:infos@hamamatsu.fr)

United Kingdom: HAMAMATSU PHOTONICS UK LIMITED: 2 Howard Court, 10 Tewin Road, Welwyn Garden City, Hertfordshire AL7 1BW, UK, Telephone: (44)1707-294888, Fax: (44)1707-325777 E-mail: [info@hamamatsu.co.uk](mailto:info@hamamatsu.co.uk)

North Europe: HAMAMATSU PHOTONICS NORDEN AB: Torshamnsgatan 35 16440 Kista, Sweden, Telephone: (46)8-509 031 00, Fax: (46)8-509 031 01 E-mail: [info@hamamatsu.se](mailto:info@hamamatsu.se)

Italy: HAMAMATSU PHOTONICS ITALIA S.R.L.: Strada della Moia, 1 int. 6, 20044 Arese (Milano), Italy, Telephone: (39)02-93 58 17 33, Fax: (39)02-93 58 17 41 E-mail: [info@hamamatsu.it](mailto:info@hamamatsu.it)

China: HAMAMATSU PHOTONICS (CHINA) CO., LTD.: 1201 Tower B, Jiaming Center, 27 Dongsanhuan Bellu, Chaoyang District, 100020 Beijing, P.R. China, Telephone: (86)10-6586-6006, Fax: (86)10-6586-2866 E-mail: [hpc@hamamatsu.com.cn](mailto:hpc@hamamatsu.com.cn)

Taiwan: HAMAMATSU PHOTONICS TAIWAN CO., LTD.: 8F-3, No.158, Section 2, Gongdao 5th Road, East District, Hsinchu, 300, Taiwan R.O.C. Telephone: (886)3-659-0080, Fax: (886)3-659-0081 E-mail: [info@hamamatsu.com.tw](mailto:info@hamamatsu.com.tw)