

X-RAY / GAMMA-RAY DETECTOR

ENERGY DIFFERENTIATION TYPE 64 CH CdTe RADIATION LINE SENSOR C10413

Accomplish X-ray and gamma-ray images with multicolor by energy differentiation

FEATURES

- High radiation detection efficiency due to direct conversion type semiconductor (CdTe) detector
- Simultaneous energy differentiation of input radiation photons by setting 5 different energy thresholds
- Parallel signal readout from each pixel
- High counting efficiency
- Eliminating effect from beam scattering and hardening by energy differentiation function
- Wide energy measurement range covering X-rays and gamma-rays spectral regions



Application 1: Simultaneous measurement of images at different energy regions

– Energy-differentiated RI* images –

* RI: radioisotope

Images were measured by linear scanning over radioisotopes (RI) with the radiation line sensor. Energy-differentiated imaging allows color visualization and identification of different radioisotopes. Images from different radioisotopes can be visualized by energy discrimination for easy color identification.

Radioisotope arrangement

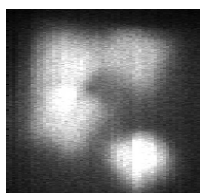
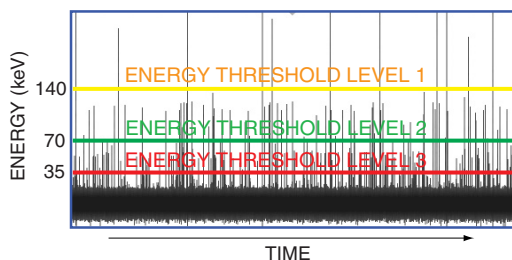
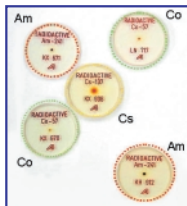

Images obtained without energy differentiation: shows only the radiation intensity distribution

Energy-differentiated images

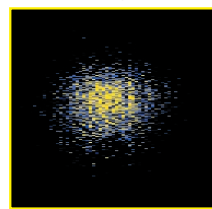

Image obtained with ¹³⁷Cs only (Energy: 140 keV or higher)

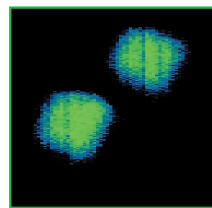

Image obtained with ⁵⁷Co only (Energy: 70 keV to 140 keV)

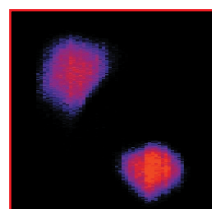
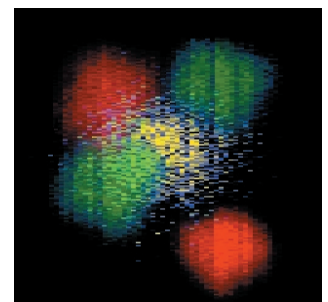

Image obtained with ²⁴¹Am only (Energy: 35 keV to 70 keV)

Composite image with energy-differentiation



Easy identification of radioisotopes

The output data of this sensor is the number of radiation photons differentiated with five comparators in each detection element. The display in color is construction as for this number of photons.

RADIATION LINE SENSOR OPERATION

Signal pulses from each detector pixel are differentiated by the five comparators according to their energy levels. These signal pulses are then counted by the five counters and output as the number of photon counting pulses.

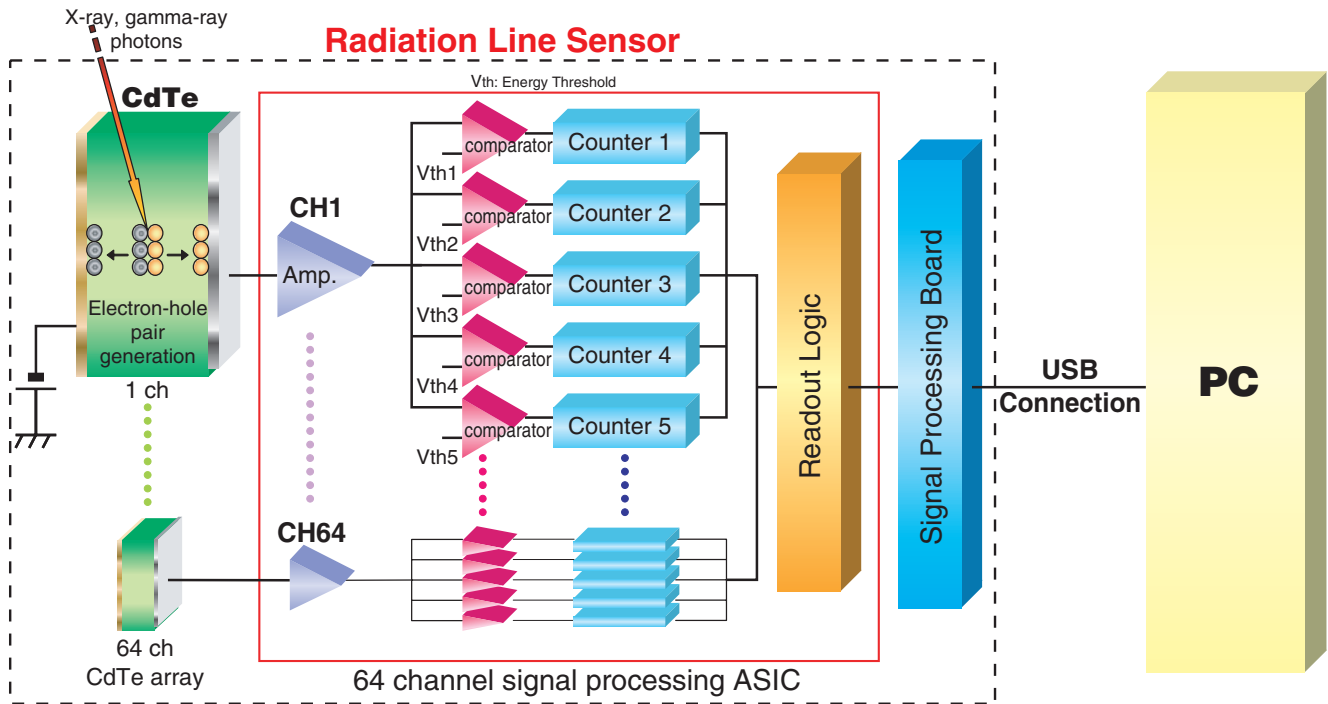

Application 2: Simultaneous measurement of images at different energy regions

– X-ray energy differentiated images –

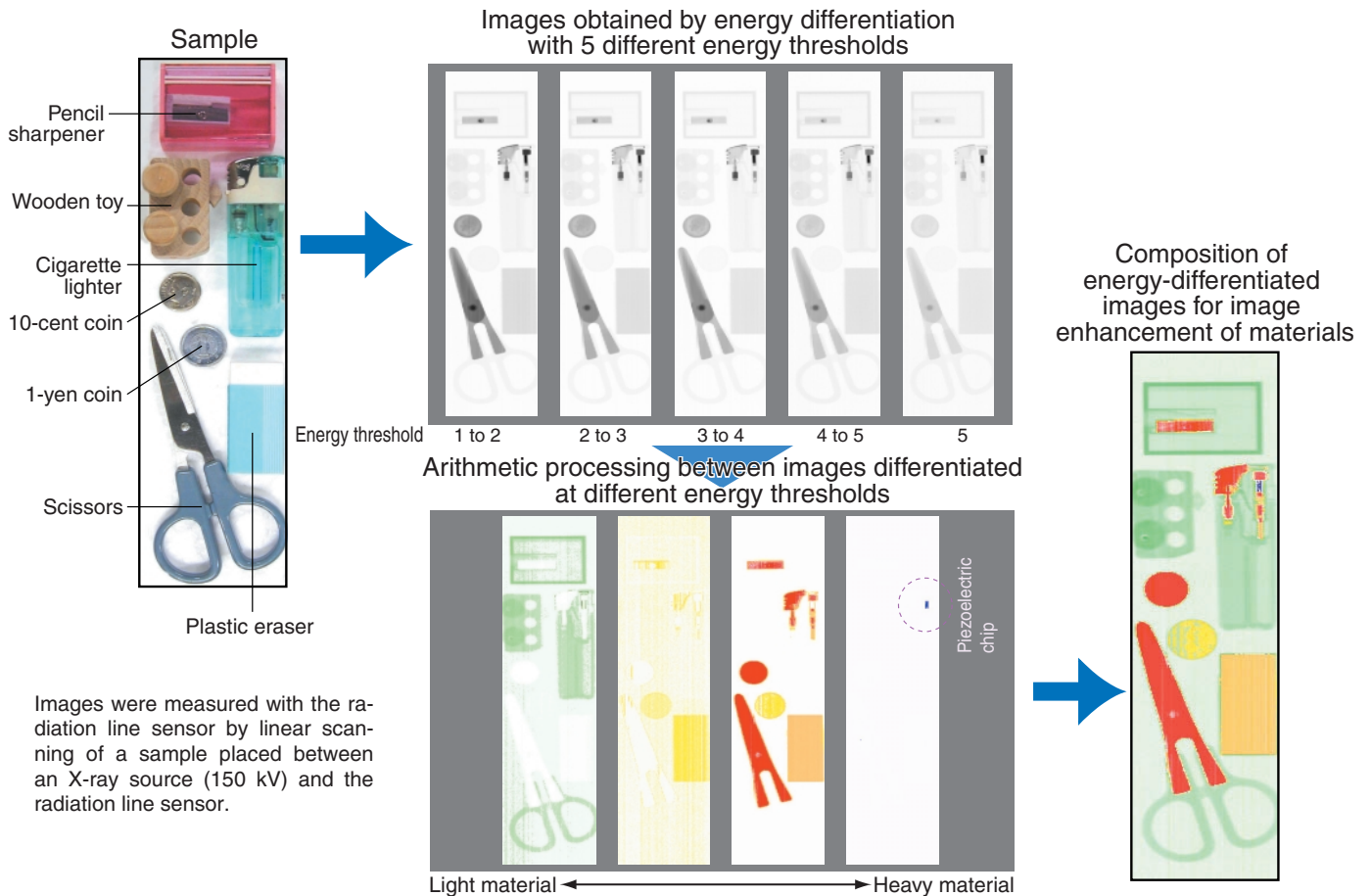

Application 3: Eliminating effect from beam scattering and hardening

Images obtained without energy differentiation are subject to effects from scattered rays and beam hardening. These scattered rays and beam hardening can be eliminated by setting the proper energy differentiation levels.

- Sample of aluminum cylinder with a copper, iron, titanium and carbon rods inserted inside the cylinder

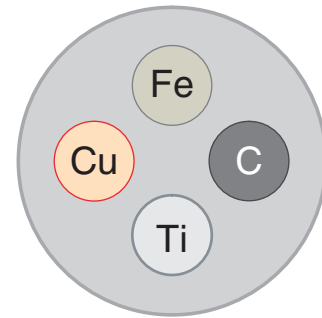
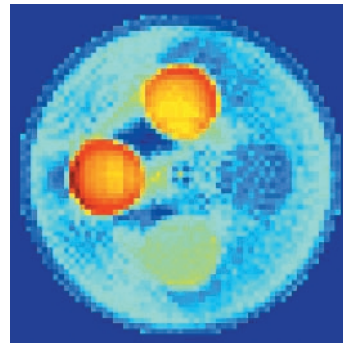
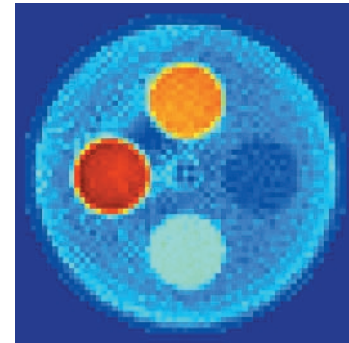

Image obtained without energy differentiation (20 keV to 150 keV)



Energy-differentiated image (90 keV or higher)



Application 4: Gamma-ray and X-ray spectrum measurement

Highly detailed spectrum measurements can be made by auto sweep of the comparator levels.

- ⁵⁷Co spectrum measurement

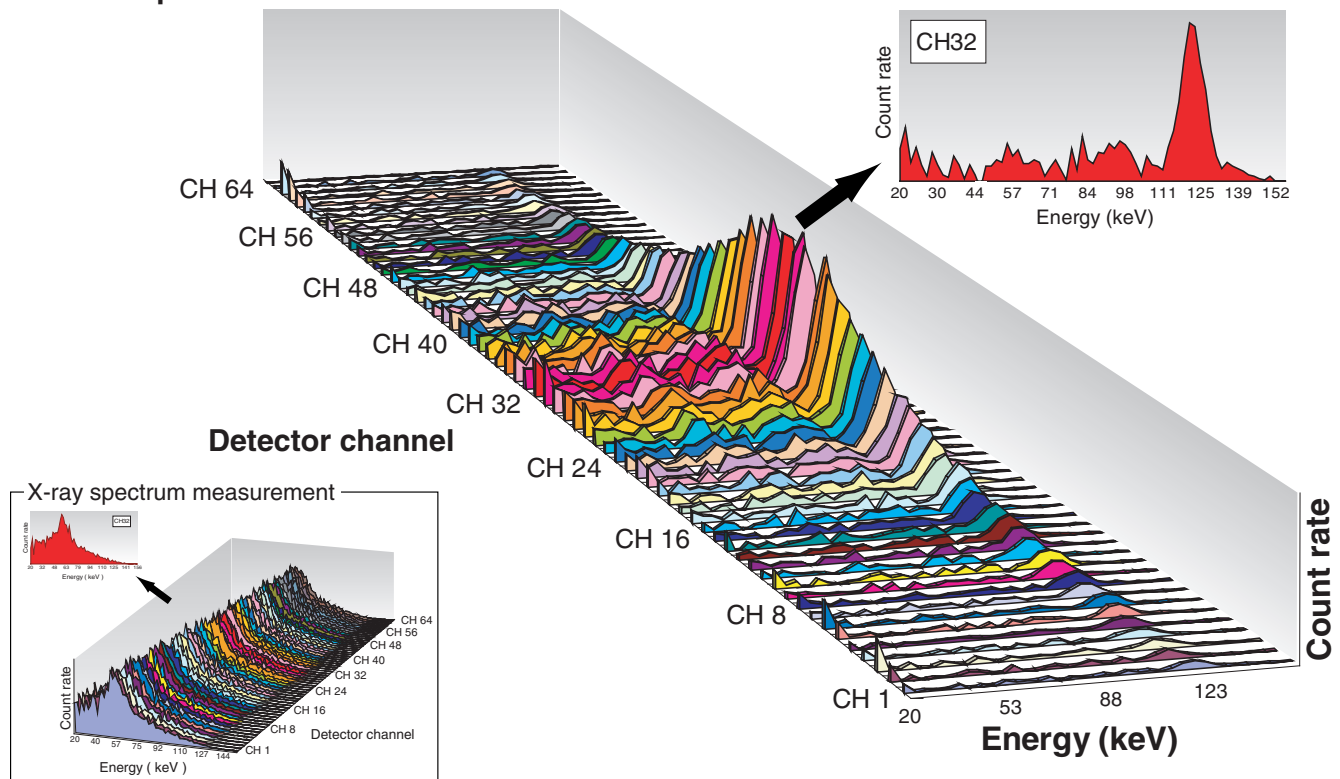

The output data of this sensor is the number of radiation photons differentiated with five comparators in each detection element. The display in color is construction as for this number of photons.

SPECIFICATIONS

Parameter	Description / Value
Detector element	Direct conversion type semiconductor (Cadmium telluride: CdTe) detector
Number of pixels	64
Pixel pitch	1 mm
Energy measurement range ^(A)	30 keV to 1000 keV
Energy resolution ^(A)	FWHM $\leq 15\%$ (at 122 keV: ⁵⁷ Co)
Detection efficiency	82 % (at 150 keV)
Number of energy thresholds	5 (Thresholds can be set at any levels within energy)
Maximum count rate per channel ^(A)	$2 \times 10^6 \text{ s}^{-1}$
Integration time (1 line)	1 ms to 4095 ms
Counter	16 bit
Interface	USB 2.0
Output ^(B)	Counter value (16 bits)
Data output format	CSV, Excel [®]
External start trigger	TTL
Compatible OS	Windows [®] 7 (32 bit, 64 bit)
Input voltage	DC 12 V (AC adapter is supplied. AC 100 V to AC 240 V)
Operating temperature range	+5 °C to +30 °C
Storage temperature range	-10 °C to +60 °C
Operating humidity range	below 85 % (no condensation)
Storage humidity range	below 85 % (no condensation)
Dimensions (W × H × D)	150 mm × 64 mm × 246 mm
Weight	2300 g

NOTE: ^(A) These parameters depend on input radiation photon energy and measurement conditions.

^(B) The output data of this sensor is the number of radiation photons differentiated with five comparators in each detection element.

DIMENSIONAL OUTLINES (Unit: mm)

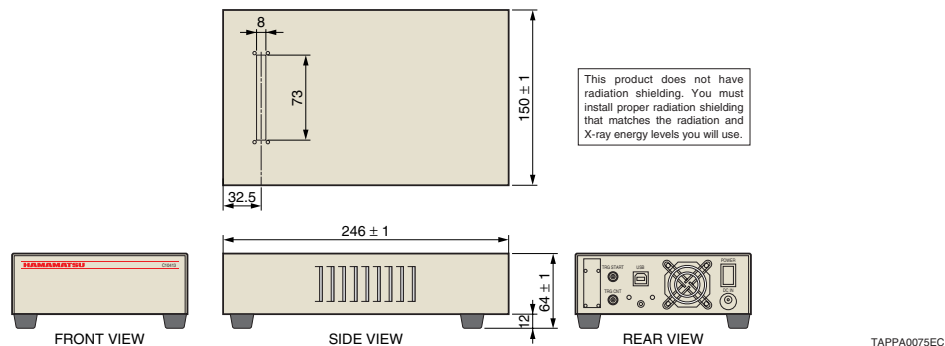

CONNECTION EXAMPLE

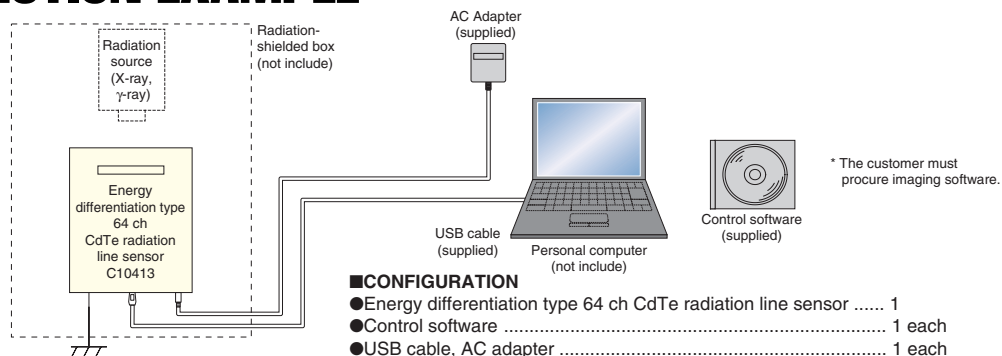

Windows[®] is a registered trademark of Microsoft Corporation in the United States and/or other countries.

Other product and software names mentioned herein may be either registered trademarks or trademarks of their respective owners.

Subject to local technical requirements and regulations, availability of products included in this promotional material may vary. Please consult with our sales office.

Information furnished by HAMAMATSU is believed to be reliable. However, no responsibility is assumed for possible inaccuracies or omissions. Specifications are subject to change without notice. No patent rights are granted to any of the circuits described herein. ©2014 Hamamatsu Photonics K.K.

HAMAMATSU PHOTONICS K.K. www.hamamatsu.com

HAMAMATSU PHOTONICS K.K., Electron Tube Division

314-5, Shimokanzo, Iwata City, Shizuoka Pref., 438-0193, Japan, Telephone: (81)539/62-5248, Fax: (81)539/62-2205

U.S.A.: Hamamatsu Corporation: 360 Foothill Road, Bridgewater, N.J. 08807-0910, U.S.A., Telephone: (1)908-231-0960, Fax: (1)908-231-1218 E-mail: usa@hamamatsu.com

Germany: Hamamatsu Photonics Deutschland GmbH: Arzbergerstr. 10, D-82211 Herrsching am Ammersee, Germany, Telephone: (49)8152-375-0, Fax: (49)8152-2658 E-mail: info@hamamatsu.de

France: Hamamatsu Photonics France S.A.R.L.: 19, Rue du Saule Trapu, Parc du Moulin de Massy, 91882 Massy Cedex, France, Telephone: (33)1 69 53 71 00, Fax: (33)1 69 53 71 10 E-mail: infos@hamamatsu.fr

United Kingdom: Hamamatsu Photonics UK Limited: 2 Howard Court, 10 Tewin Road, Welwyn Garden City, Hertfordshire AL7 1BW, United Kingdom, Telephone: (44)1707-294888, Fax: (44)1707-325777 E-mail: info@hamamatsu.co.uk

North Europe: Hamamatsu Photonics Norden AB: Torshamnsgatan 35 SE-164 40 Kista, Sweden, Telephone: (46)8-509-031-00, Fax: (46)8-509-031-01 E-mail: info@hamamatsu.se

Italy: Hamamatsu Photonics Italia S.r.l.: Strada della Moia, 1 int. 6, 20020 Arese (Milano), Italy, Telephone: (39)02-93581733, Fax: (39)02-93581741 E-mail: info@hamamatsu.it

China: Hamamatsu Photonics (China) Co., Ltd.: B1201 Jiaming Center, No.27 Dongshanhuan Bellu, Chaoyang District, Beijing 100020, China, Telephone: (86)10-6586-6006, Fax: (86)10-6586-2866 E-mail: hpc@hamamatsu.com.cn

TAPP1066E03
NOV. 2014 IP