

# InGaAs PIN photodiode

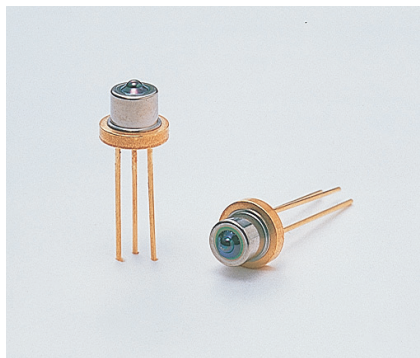

G6854-01

**Spherical lens window package for efficient fiber coupling**

## Features

- Easy optical axis alignment
- High fiber coupling efficiency
- CD package  
High degree of base positioning accuracy allows easy positioning.
- Package weldable by YAG laser
- Spherical lens window with AR coating minimizes return light input

## Applications

- Optical fiber communications

## Absolute maximum ratings (Ta=25 °C)

Parameter	Symbol	Value	Unit
Reverse voltage	V <sub>R</sub> Max.	20	V
Operating temperature	T <sub>opr</sub>	-40 to +85	°C
Storage temperature	T <sub>stg</sub>	-55 to +125	°C

## Electrical and optical characteristics (Ta=25 °C)

Parameter	Symbol	Condition	Min.	Typ.	Max.	Unit
Spectral response range	$\lambda$		-	0.9 to 1.7	-	$\mu\text{m}$
Peak sensitivity wavelength	$\lambda_p$		-	1.55	-	$\mu\text{m}$
Photo sensitivity	S	$\lambda=1.3 \mu\text{m}$	0.8	0.9	-	A/W
		$\lambda=1.55 \mu\text{m}$	0.85	0.95	-	A/W
Dark current	I <sub>D</sub>	V <sub>R</sub> =5 V	-	80	400	pA
Cutoff frequency	f <sub>c</sub>	V <sub>R</sub> =5 V, R <sub>L</sub> =50 $\Omega$ $\lambda=1.3 \mu\text{m}$ , -3 dB	1	2	-	GHz
Terminal capacitance	C <sub>t</sub>	V <sub>R</sub> =5 V, f=1 MHz	-	1	1.5	pF
Shunt resistance	R <sub>sh</sub>	V <sub>R</sub> =10 mV	-	8	-	G $\Omega$
Detectivity	D*	$\lambda=\lambda_p$	-	$5 \times 10^{12}$	-	cm · Hz <sup>1/2</sup> /W
Noise equivalent power	NEP	$\lambda=\lambda_p$	-	$2 \times 10^{-15}$	-	W/Hz <sup>1/2</sup>

G6854-01 may be damaged by Electro Static Discharge, etc. Be carefull when using G6854-01.

**Spectral response**

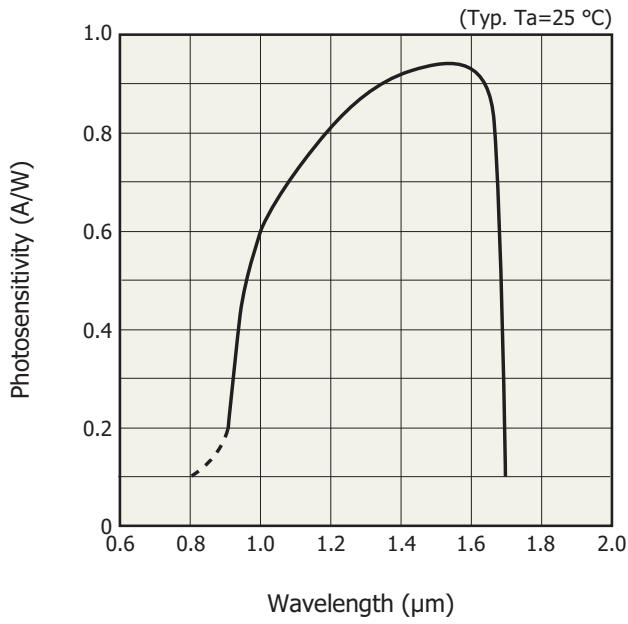

**Dark current vs. reverse voltage**

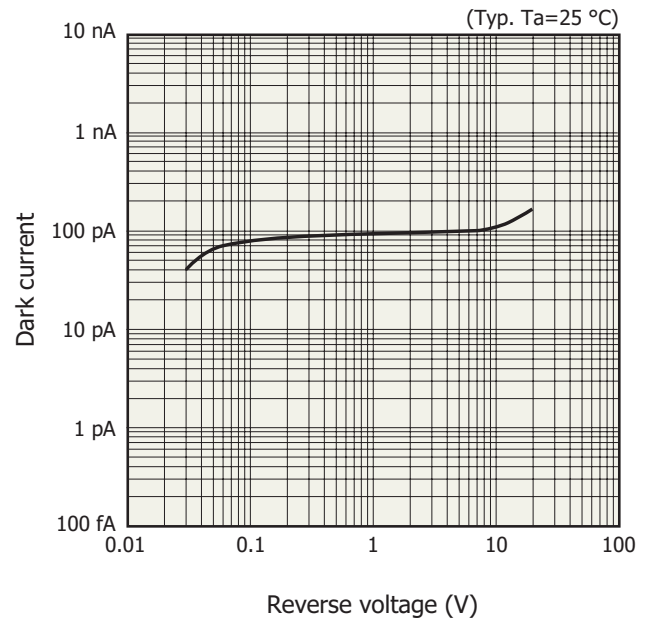

**Terminal capacitance vs. reverse voltage**

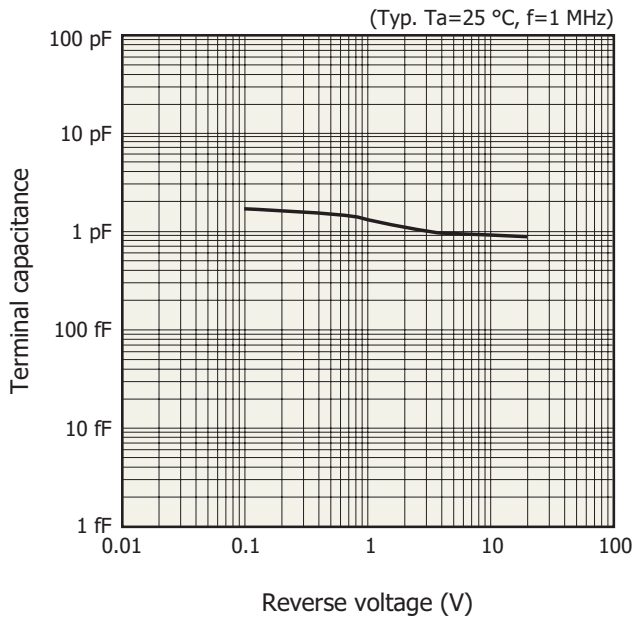

**Frequency response**

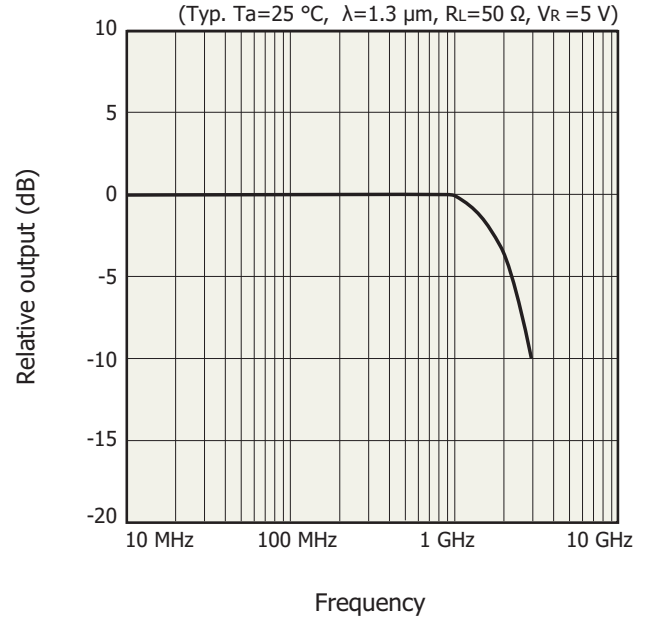

❑ Fiber coupling characteristic (X, Y axes)

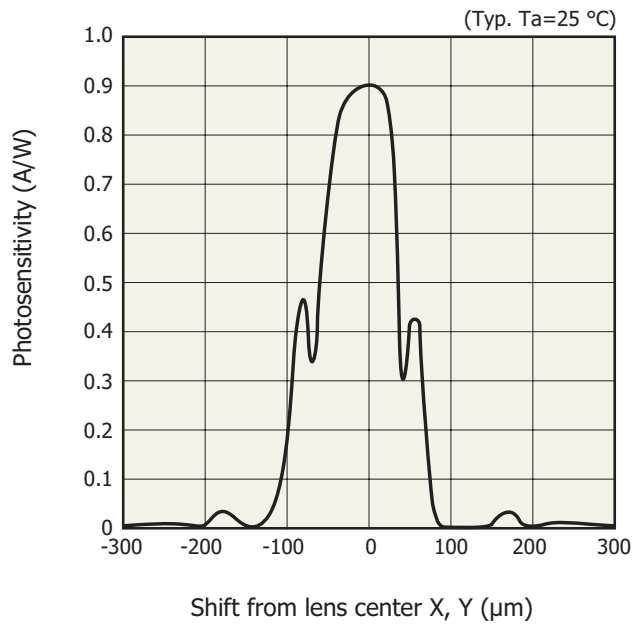

KIRDB0155EC

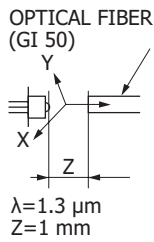

KIRDC0042EA

❑ Fiber coupling characteristic (Z axis)

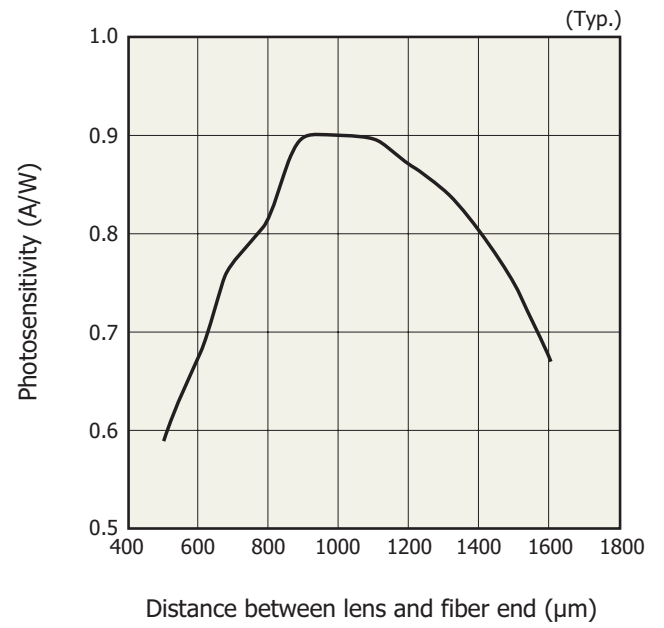

KIRDB0156EC

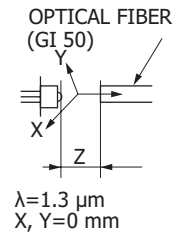

KIRDC0043EA

### Dimensional outline (unit: mm)

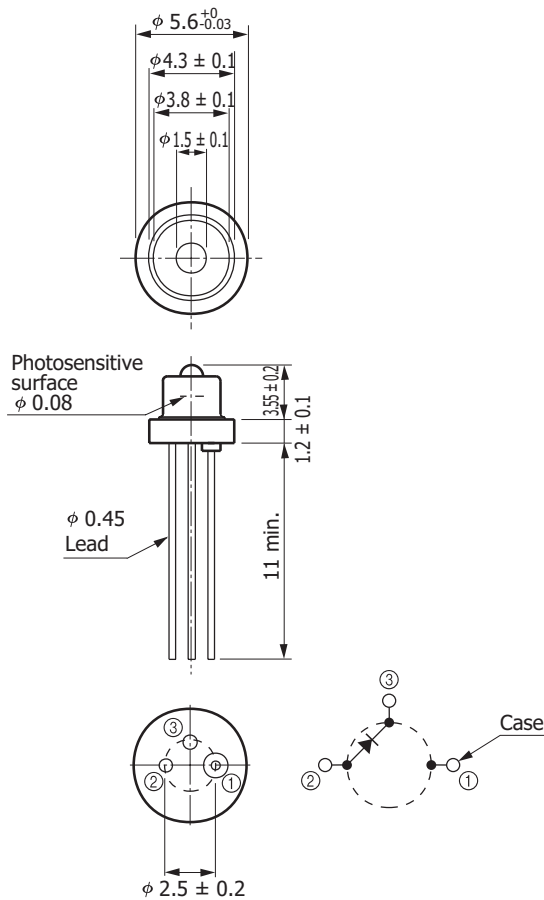

KIRDA0063ED

### Related information

[www.hamamatsu.com/sp/ssd/doc\\_en.html](http://www.hamamatsu.com/sp/ssd/doc_en.html)

#### ■ Precautions

- Disclaimer
- Metal, ceramic, plastic package products

#### ■ Technical information

- Infrared detectors

Information described in this material is current as of September 2017.

Product specifications are subject to change without prior notice due to improvements or other reasons. This document has been carefully prepared and the information contained is believed to be accurate. In rare cases, however, there may be inaccuracies such as text errors. Before using these products, always contact us for the delivery specification sheet to check the latest specifications.

The product warranty is valid for one year after delivery and is limited to product repair or replacement for defects discovered and reported to us within that one year period. However, even if within the warranty period we accept absolutely no liability for any loss caused by natural disasters or improper product use. Copying or reprinting the contents described in this material in whole or in part is prohibited without our prior permission.

# HAMAMATSU

[www.hamamatsu.com](http://www.hamamatsu.com)

HAMAMATSU PHOTONICS K.K., Solid State Division

1126-1 Ichino-cho, Higashi-ku, Hamamatsu City, 435-8558 Japan, Telephone: (81) 53-434-3311, Fax: (81) 53-434-5184

U.S.A.: Hamamatsu Corporation: 360 Foothill Road, Bridgewater, N.J. 08807, U.S.A., Telephone: (1) 908-231-0960, Fax: (1) 908-231-1218

Germany: Hamamatsu Photonics Deutschland GmbH: Arzbergerstr. 10, D-82211 Herrsching am Ammersee, Germany, Telephone: (49) 8152-375-0, Fax: (49) 8152-265-8

France: Hamamatsu Photonics France S.A.R.L.: 19, Rue du Saule Trapu, Parc du Moulin de Massy, 91882 Massy Cedex, France, Telephone: 33-(1) 69 53 71 00, Fax: 33-(1) 69 53 71 10

United Kingdom: Hamamatsu Photonics UK Limited: 2 Howard Court, 10 Tewin Road, Welwyn Garden City, Hertfordshire AL7 1BW, United Kingdom, Telephone: (44) 1707-294888, Fax: (44) 1707-325777

North Europe: Hamamatsu Photonics Norden AB: Torshamnsgatan 35 16440 Kista, Sweden, Telephone: (46) 8-509-031-00, Fax: (46) 8-509-031-01

Italy: Hamamatsu Photonics Italia S.r.l.: Strada della Moia, 1 int. 6, 20020 Arese (Milano), Italy, Telephone: (39) 02-93581733, Fax: (39) 02-93581741

China: Hamamatsu Photonics (China) Co., Ltd.: B1201, Jiaming Center, No.27 Dongsanhuan Beilu, Chaoyang District, Beijing 100020, China, Telephone: (86) 10-6586-6006, Fax: (86) 10-6586-2866