

# Characteristics and use of photo IC diodes

## 1 Overview

The photo IC diodes are devices that boost the photocurrent generated from a photodiode approx. 1300 times (or 30000 times). They output current and can be used in the same way as a photodiode applied with a reverse bias.

The photo IC diodes are used in various types of light level detection applications. For example, a type with a spectral response close to human eye sensitivity is used as an energy-saving sensor to adjust the brightness of TVs and the like.

### » Features

The photo IC diodes are two-terminal devices that are as easy to use as a photodiode yet produce a large current equivalent to that of a phototransistor. It also has good linearity characteristics.

Table 1 shows the photo IC diode lineup. When classified by spectral response, there are two types available: infrared and visual-sensitive compensation. The visual-sensitive compensation type provides a spectral response close to human eye sensitivity without a visual-sensitive compensation filter.

[Figure 1] Spectral response

(a) Infrared type (①)

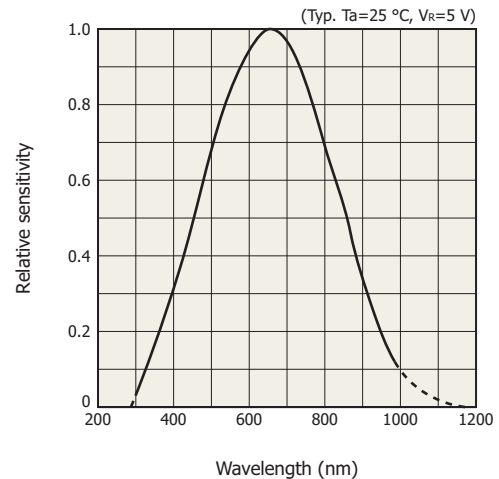

KP1C80036EA

(b) Visual-sensitive compensation type (②)

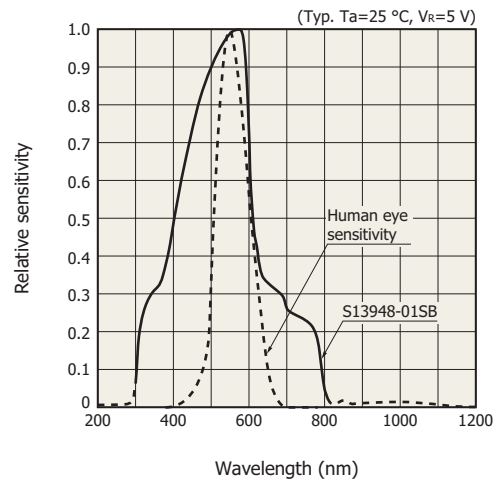

KP1C80239EA

[Table 1] Photo IC diode lineup

Product	Type	Package (plastic)	Peak sensitivity wavelength (nm)	Photocurrent 2856 K, 100 lx (mA)
S7183	① Infrared type	SIP with lens	650	1.0
S7184		Surface mount type		0.18
S9066-211SB	② Visual-sensitive compensation type	SIP	560	0.19 to 0.35
S9067-201CT		Surface mount type		0.18 to 0.34
S13948-01SB		Head-on type (same form as the CdS cell 5R type)		0.18 to 0.34
S10604-200CT		Surface mount type		0.21 to 0.39
S11153-01MT		Surface mount type		0.325 to 0.495
S11154-201CT		③ Surface mount type		580

(c) Visual-sensitive compensation type (③)

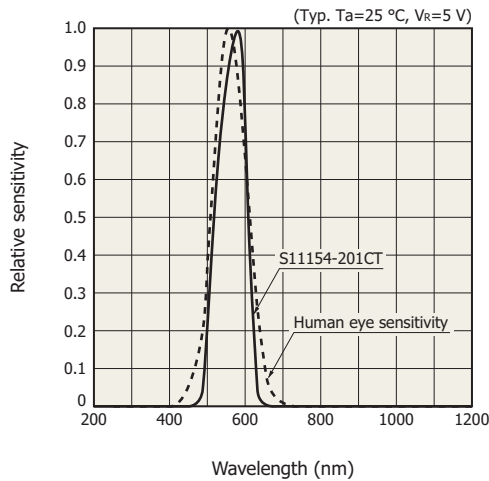

KPICB0129EB

2 Structure

Figure 2 shows a photo IC diode application circuit example. The photo IC diode amplifies the photocurrent generated by a photodiode.

[Figure 2] Application circuit example (①)

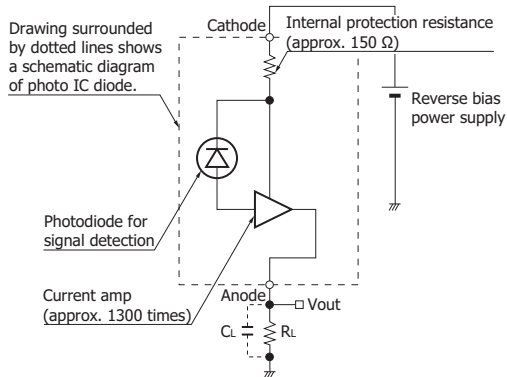

KPIC0018EC

3 Characteristics

This section explains the characteristics of a typical photo IC diode S13948-01SB.

Figure 3 is an application circuit example of the visual-sensitive compensation type.

There are two photosensitive areas on the chip, one for signal detection and another for compensation with sensitivities only in the near infrared region. An internal arithmetic circuit subtracts the photocurrent of the photodiode for compensation from the photocurrent of the photodiode for signal detection resulting in a spectral response with sensitivities limited more or less to the visible region. The signal is then amplified by a current amplifier and is output.

Figure 4 shows the linearity of the photocurrent. If the illuminance exceeds 500 lx, the linearity tends to degrade.

[Figure 3] Application circuit example (②③)

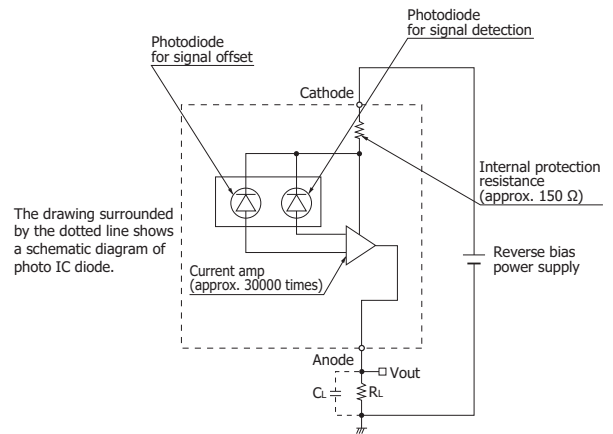

KPIC0091ED

[Figure 4] Photocurrent vs. illuminance (S13948-01SB)

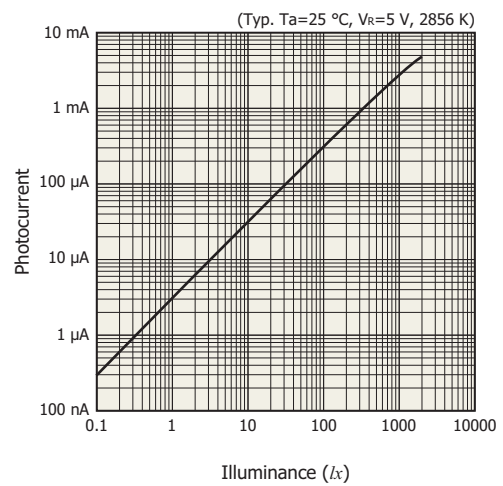

KPICB0083EC

[Figure 5] Dark current vs. ambient temperature (S13948-01SB)

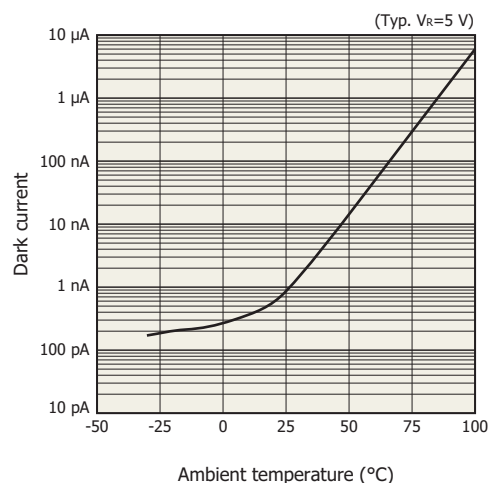

KPICB0157EB

[Figure 6] Photocurrent vs. ambient temperature (S13948-01SB)

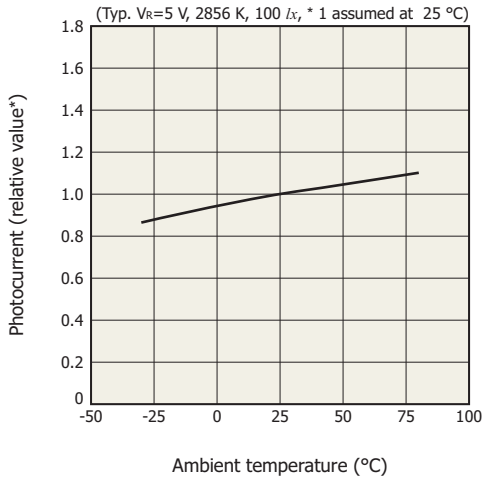

KPICB0158EB

[Figure 7] Dark current vs. reverse voltage (S13948-01SB)

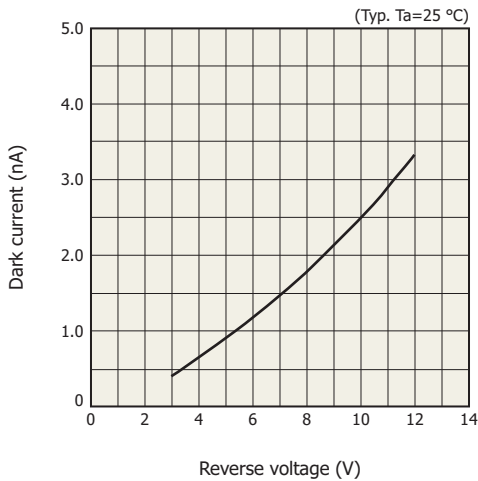

KPICB0159EA

[Figure 8] Rise and fall times vs. load resistance (S13948-01SB)

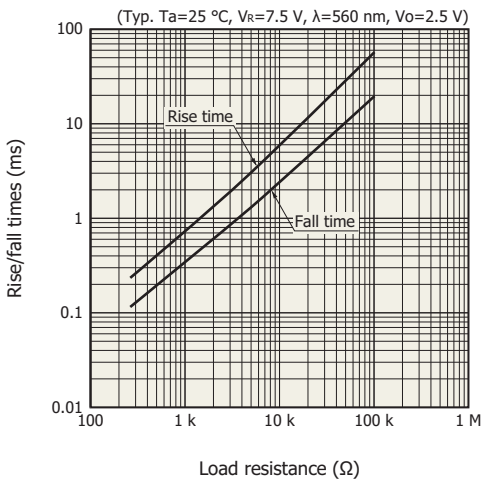

KPICB0077EB

[Figure 9] Directivity (S13948-01SB)

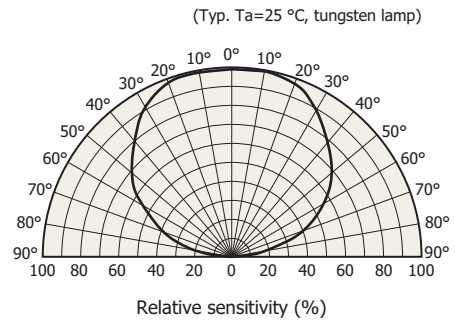

KPICB0174EA

[Figure 10] Color temperature distribution producing the same integral value at human eye sensitivity

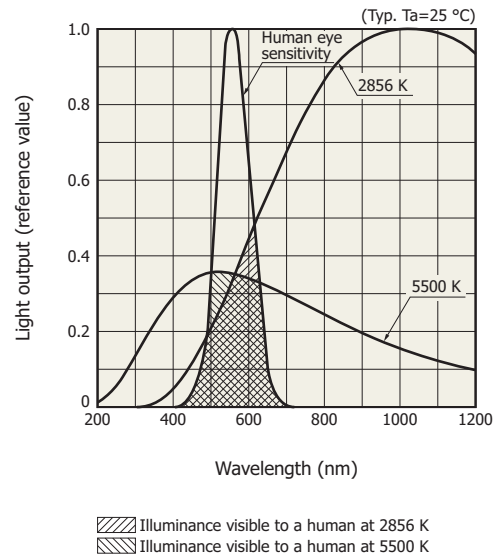

KPICB0105EA

Figure 10 shows the human eye sensitivity curve (characteristics of the human eye sensitivity to light) and color temperature spectra. The graph is plotted so that the illuminance observed by a person is the same for each color temperature. It is desirable for the sensor's spectral response to match the human eye sensitivity curve, but in reality, there is deviation. This deviation causes color temperature error output. If we assume an incandescent lamp that includes light output in the infrared region and a fluorescent lamp that hardly includes it having the same illuminance, the output values detected by a sensor that has sensitivities in the infrared region will be different. A visual-sensitive compensation type photo IC diode, such as the S11154-201CT, does not use an external visual-sensitive compensation filter, but its spectral response is adjusted close to human eye sensitivity to reduce color temperature error output (see Figure 11).

[Figure 11] Light source color temperature vs. output

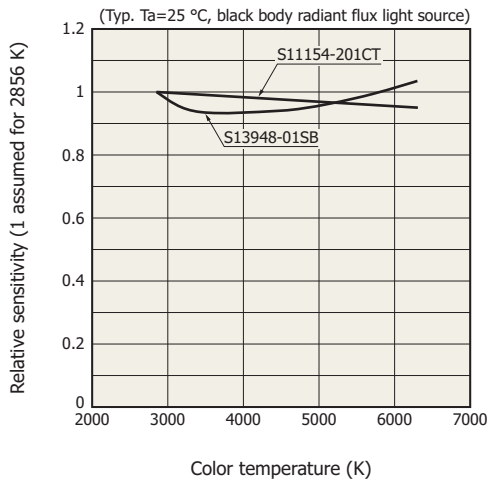

KPICB0106ED

## 4 How to use

Because the photo IC diode amplifies the photocurrent to output current, a large output voltage can be obtained by connecting a load resistance. Connect the cathode so that a positive potential is applied to it [Figures 2, Figure 3]. If high-frequency components must be eliminated, we recommend that a low-pass filter load capacitance (CL) be inserted in parallel with the load resistance (RL). In this case, the cutoff frequency (fc) is expressed by equation (1).

$$f_c = \frac{1}{2\pi C_L R_L} \dots\dots\dots (1)$$

Figure 13 shows the photocurrent vs. reverse voltage characteristics (light source: LED) for the measurement circuit example in Figure 12. The output curves are shown for each illuminance level of light source A conversion. The output curve rises from a reverse voltage (rising voltage) of approximately 0.7 V. To protect the internal circuit in the event a current exceeding the absolute maximum rating flows, a protection resistor of approximately 150 Ω (±20%) is inserted. Reverse voltage (VR) when the photo IC diode is saturated is the sum of Vbe(ON) and the voltage drop across protective resistor (Rin).

$$V_R = V_{be(ON)} + I_L \times R_{in} \dots\dots\dots (2)$$

[Figure 12] Measurement circuit example

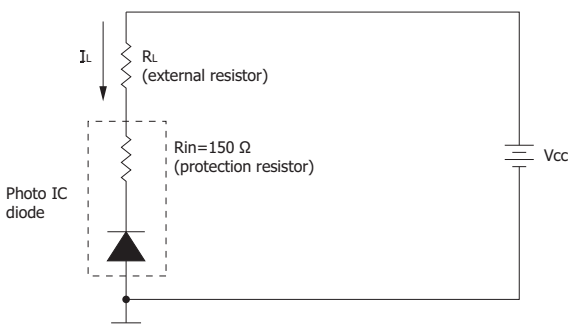

KPICC0128ED

The photo IC diode's reverse voltage (VR) is expressed by equation (3) according to the voltage drop across the external resistor. This is indicated as load lines in Figure 13.

$$V_R = V_{cc} - I_L \times R_L \dots\dots\dots (3)$$

In Figure 13, the intersections between the output curves and the load lines are the saturation points. From these points, the maximum detectable light level can be specified. As the maximum light level is determined by supply voltage (Vcc) and load resistance (RL), change them according to your conditions.

Note: Vbe(ON) has a temperature characteristics of approximately -2 mV/°C, and the protective resistor approximately 0.1%/°C.

[Figure 13] Photocurrent vs. reverse voltage (S13948-01SB)

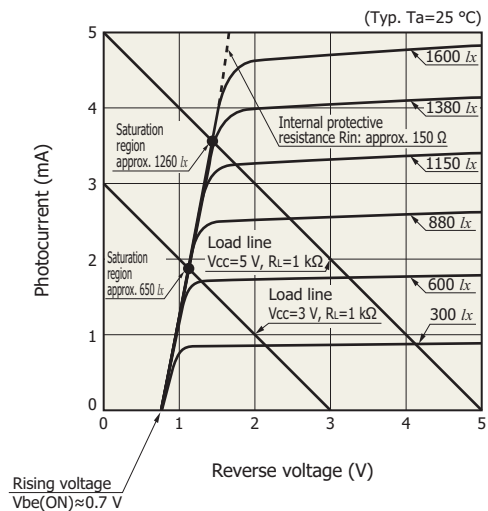

KPICB0107EC

Information described in this material is current as of May 2018.

Product specifications are subject to change without prior notice due to improvements or other reasons. This document has been carefully prepared and the information contained is believed to be accurate. In rare cases, however, there may be inaccuracies such as text errors. Before using these products, always contact us for the delivery specification sheet to check the latest specifications.

The product warranty is valid for one year after delivery and is limited to product repair or replacement for defects discovered and reported to us within that one year period. However, even if within the warranty period we accept absolutely no liability for any loss caused by natural disasters or improper product use. Copying or reprinting the contents described in this material in whole or in part is prohibited without our prior permission.

# HAMAMATSU

[www.hamamatsu.com](http://www.hamamatsu.com)

HAMAMATSU PHOTONICS K.K., Solid State Division

1126-1 Ichino-cho, Higashi-ku, Hamamatsu City, 435-8558 Japan, Telephone: (81) 53-434-3311, Fax: (81) 53-434-5184

U.S.A.: Hamamatsu Corporation: 360 Foothill Road, Bridgewater, N.J. 08807, U.S.A., Telephone: (1) 908-231-0960, Fax: (1) 908-231-1218, E-mail: [usa@hamamatsu.com](mailto:usa@hamamatsu.com)

Germany: Hamamatsu Photonics Deutschland GmbH: Arzbergerstr. 10, D-82211 Herrsching am Ammersee, Germany, Telephone: (49) 8152-375-0, Fax: (49) 8152-265-8, E-mail: [info@hamamatsu.de](mailto:info@hamamatsu.de)

France: Hamamatsu Photonics France S.A.R.L.: 19, Rue du Saule Trapu, Parc du Moulin de Massy, 91882 Massy Cedex, France, Telephone: 33-(1) 69 53 71 00, Fax: 33-(1) 69 53 71 10, E-mail: [infos@hamamatsu.fr](mailto:infos@hamamatsu.fr)

United Kingdom: Hamamatsu Photonics UK Limited: 2 Howard Court, 10 Tewin Road, Welwyn Garden City, Hertfordshire AL7 1BW, United Kingdom, Telephone: (44) 1707-294888, Fax: (44) 1707-325777, E-mail: [info@hamamatsu.co.uk](mailto:info@hamamatsu.co.uk)

North Europe: Hamamatsu Photonics Norden AB: Torshamnsgatan 35 16440 Kista, Sweden, Telephone: (46)8-509 031 00, Fax: (46)8-509 031 01, E-mail: [info@hamamatsu.se](mailto:info@hamamatsu.se)

Italy: Hamamatsu Photonics Italia S.r.l.: Strada della Moia, 1 int. 6, 20020 Arese (Milano), Italy, Telephone: (39)02-93 58 17 33, Fax: (39)02-93 58 17 41, E-mail: [info@hamamatsu.it](mailto:info@hamamatsu.it)

China: Hamamatsu Photonics (China) Co., Ltd.: B1201, Jiaming Center, No.27 Dongsanhuan Beilu, Chaoyang District, Beijing 100020, China, Telephone: (86) 10-6586-6006, Fax: (86) 10-6586-2866, E-mail: [hpc@hamamatsu.com.cn](mailto:hpc@hamamatsu.com.cn)

Taiwan: Hamamatsu Photonics Taiwan Co., Ltd.: 8F-3, No. 158, Section2, Gongdao 5th Road, East District, Hsinchu, 300, Taiwan R.O.C. Telephone: (886)03-659-0080, Fax: (886)03-659-0081, E-mail: [info@hamamatsu.com.tw](mailto:info@hamamatsu.com.tw)

Cat. No. KPIC9007E04 May 2018 DN