



S14241

## Surface mount type PSD with 12 mm resistance length

The S14241 is a one-dimensional PSD designed for precise distance measurement. It is a surface mount type PSD with a photosensitive area of 1 × 12 mm, and supports reflow mounting.

### Features

- Excellent position detectability
- High reliability
- Compatible with lead-free solder reflow

### Applications

- Distance measurement
- Displacement meters
- Proximity switches

### Structure

Parameter	Symbol	Specification	Unit
Photosensitive area	A	1 × 12	mm
Package	-	Plastic	-
Window material	-	Silicone resin	-
Resistance length	RI	12	mm

### Absolute maximum ratings

Parameter	Symbol	Condition	Value	Unit
Reverse voltage	VR		20	V
Operating temperature	Topr	No dew condensation*1	-10 to +60	°C
Storage temperature	Tstg	No dew condensation*1	-20 to +80	°C
Soldering temperature	Tsol		260 (3 times)*2	°C

\*1: When there is a temperature difference between a product and the surrounding area in high humidity environments, dew condensation may occur on the product surface. Dew condensation on the product may cause deterioration in characteristics and reliability.

\*2: See P.5. JEDEC J-STD-020 MSL 3

Note: Exceeding the absolute maximum ratings even momentarily may cause a drop in product quality. Always be sure to use the product within the absolute maximum ratings.

**Electrical and optical characteristics (Ta=25 °C)**

Parameter	Symbol	Condition	Min.	Typ.	Max.	Unit
Spectral response range	$\lambda$		-	380 to 1000	-	nm
Peak sensitivity wavelength	$\lambda_p$		-	940	-	nm
Photosensitivity	S	$\lambda=\lambda_p$	-	0.57	-	A/W
Interelectrode resistance	Rie	Vb=0.1 V	30	50	80	k $\Omega$
Position detection error*3	Er	Light spot size= $\phi$ 200 $\mu$ m VR=5 V	-	$\pm$ 60	$\pm$ 240	$\mu$ m
Saturation photocurrent*4	Isat	VR=5 V, RL=1 k $\Omega$	-	100	-	$\mu$ A
Dark current	ID	VR=20 V	-	0.2	20	nA
Temperature coefficient of ID	$\Delta TID$	VR=20 V	-	1.15	-	times/ $^{\circ}$ C
Rise time	tr	VR=5 V, RL=1 k $\Omega$ $\lambda$ =900 nm, 10 to 90%	-	3	-	$\mu$ s
Terminal capacitance	Ct	VR=5 V, f=10 kHz	-	55	-	pF
Position resolution*5	POSreso		-	0.3	-	$\mu$ m

\*3: A range of 75% of that from the center of the photosensitive surface to the edge

\*4: The upper limit of linearity of photocurrent in response to the quantity of light is defined as the point where the linearity deviates by 10%.

\*5: This is the minimum detectable light spot displacement. The detection limit is indicated by the distance on the photosensitive surface. The numerical value of the resolution of a position sensor using a PSD is proportional to both the length of the PSD and the noise of the measuring system (resolution deteriorates) and inversely proportional to the photocurrent (incident energy) of the PSD (resolution improves).

- Light source: LED (900 nm)
- Light spot size:  $\phi$ 200  $\mu$ m
- Frequency range: 1 kHz
- Photocurrent: 1  $\mu$ A
- Circuit system input noise: 1  $\mu$ V (1 kHz)
- Interelectrode resistance: Typical value (refer to the specification table)

**Spectral response**

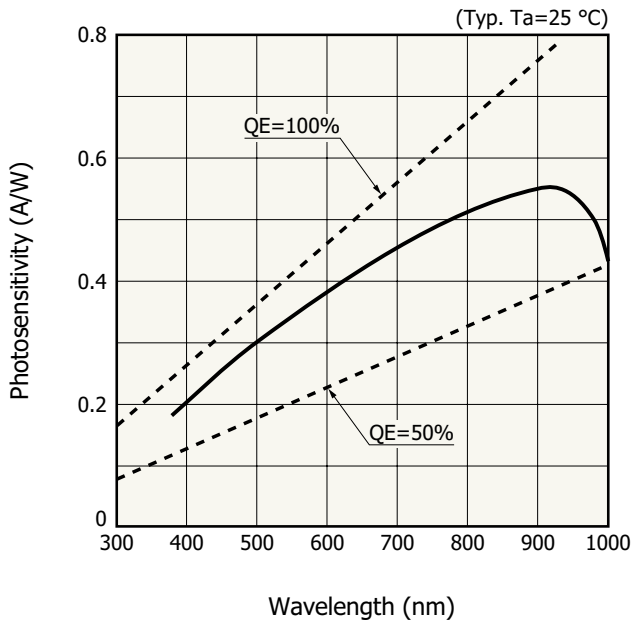

KPSDB0122EA

**Photosensitivity temperature characteristics**

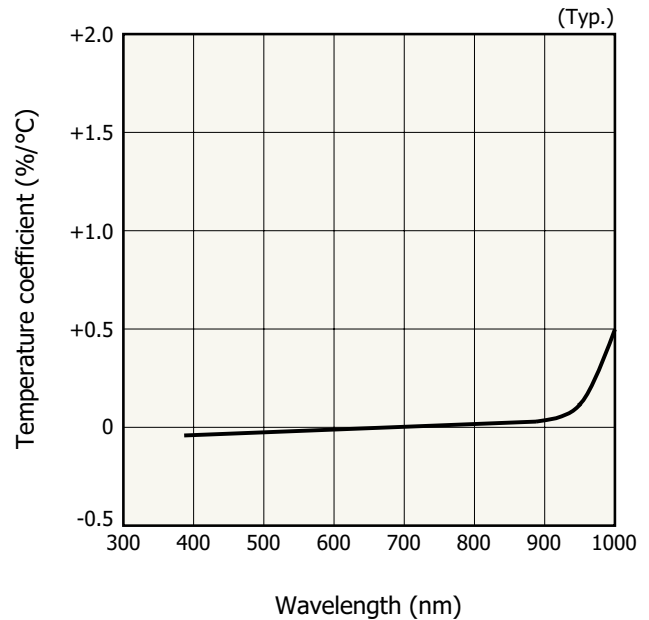

KPSDB0123EA

**Dark current vs. reverse voltage**

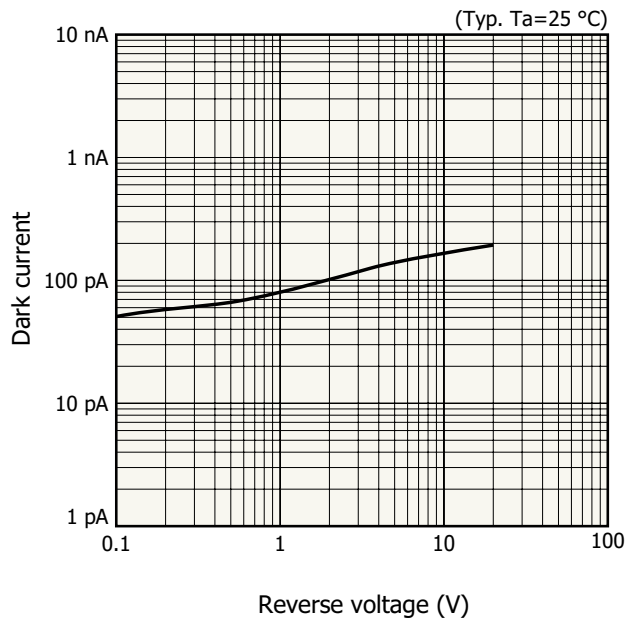

**Terminal capacitance vs. reverse voltage**

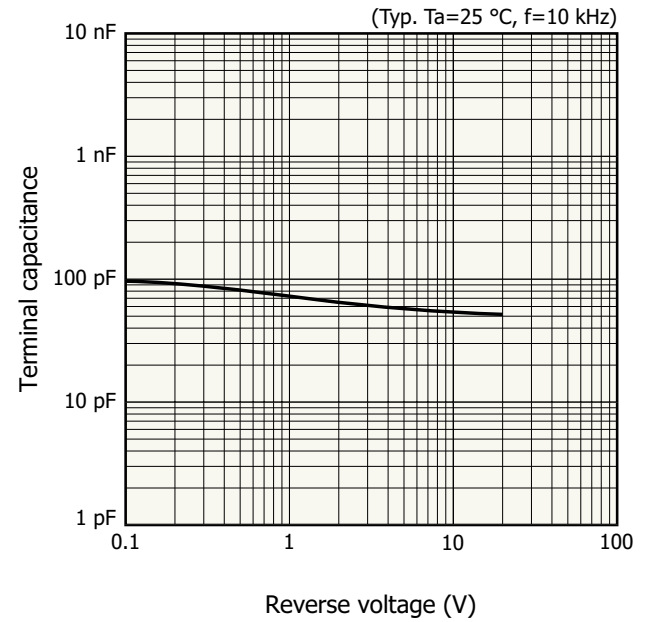

**Example of position detectability**

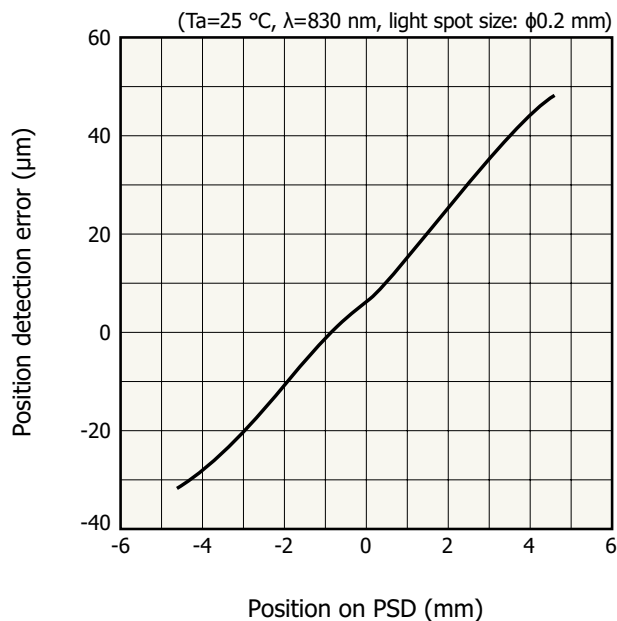

**Conversion formula of light spot position on the PSD**

Output signals (photocurrent)  $I_1$  and  $I_2$  obtained from electrodes X1 and X2, and the light spot position  $x$  on the PSD can be found by the following formula.

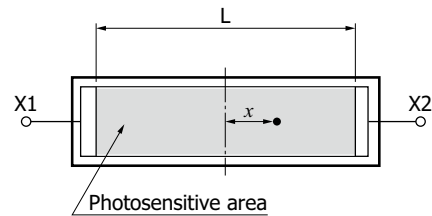

$$\frac{I_2 - I_1}{I_1 + I_2} = \frac{2x}{L}$$

$I_1$ : Output signal from electrode X1

$I_2$ : Output signal from electrode X2

$x$ : Light spot position

$L$ : Photosensitive area size (Resistance length)  
12 mm

Dimensional outline (unit: mm)

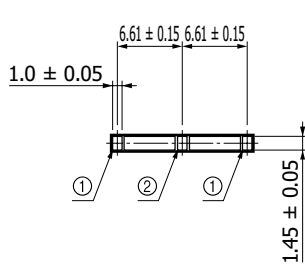
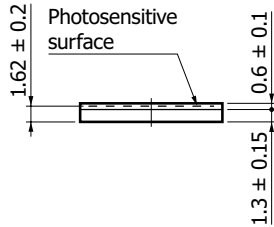
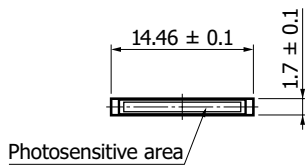

① Anode  
 ② Cathode  
 Chip position accuracy  
 with respect to base  
 edge  
 X, Y ≤ ±0.15

KPSDA0066EA

Recommended land pattern (unit: mm)

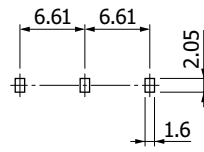

KPSDC0096EA

Standard packing specifications

■ Reel (conforms to JEITA ET-7200)

Outer diameter	Hub diameter	Tape width	Material	Electrostatic characteristic
φ254 mm	φ100 mm	24 mm	PS	Conductive

■ Embossed tape (unit: mm, material: PS, conductive)

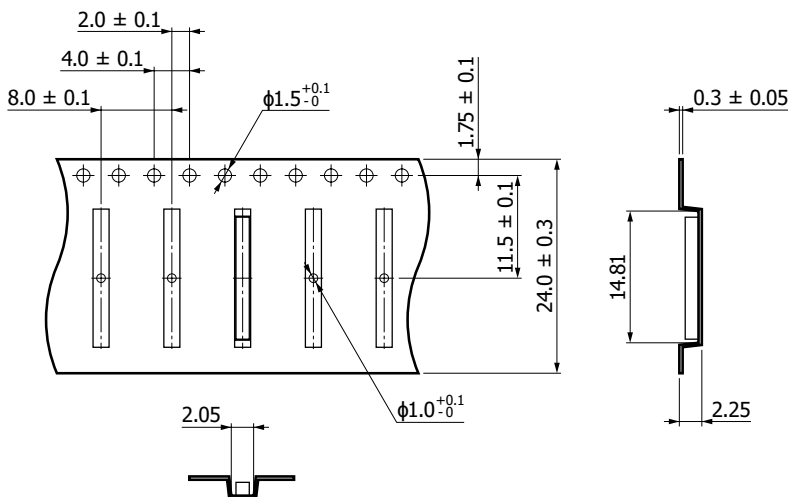

KPSDC0097EA

■ Packing quantity

100 pcs/reel

■ Packing state

Reel and desiccant in moisture-proof packaging (vacuum-sealed)

### Recommended reflow soldering conditions

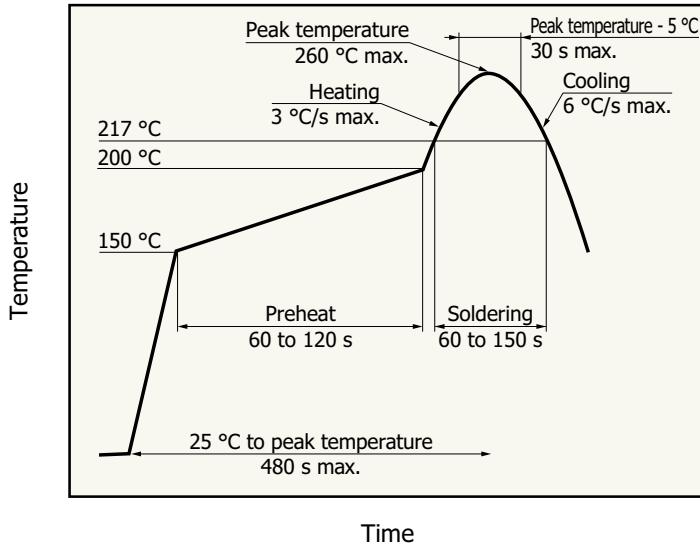

- After unpacking, keep it in an environment at 30 °C or less and a humidity of 60% or less, and perform soldering within 168 hours.
- The effect that the product receives during reflow soldering varies depending on the circuit board and the reflow oven that are used. When you set reflow soldering conditions, check that problems do not occur in the product by testing out the conditions in advance.

KSPDB0419EA

### Related information

[www.hamamatsu.com/sp/ssd/doc\\_en.html](http://www.hamamatsu.com/sp/ssd/doc_en.html)

- Precautions
  - Disclaimer
  - Precautions / Surface mount type products
- Catalogs
  - Technical note / PSD

Information described in this material is current as of January 2025.

Product specifications are subject to change without prior notice due to improvements or other reasons. This document has been carefully prepared and the information contained is believed to be accurate. In rare cases, however, there may be inaccuracies such as text errors. Before using these products, always contact us for the delivery specification sheet to check the latest specifications.

The product warranty is valid for one year after delivery and is limited to product repair or replacement for defects discovered and reported to us within that one year period. However, even if within the warranty period we accept absolutely no liability for any loss caused by natural disasters or improper product use. Copying or reprinting the contents described in this material in whole or in part is prohibited without our prior permission.

# HAMAMATSU

[www.hamamatsu.com](http://www.hamamatsu.com)

HAMAMATSU PHOTONICS K.K., Solid State Division

1126-1 Ichino-cho, Chuo-ku, Hamamatsu City, 435-8558 Japan, Telephone: (81)53-434-3311, Fax: (81)53-434-5184

U.S.A.: HAMAMATSU CORPORATION: 360 Foothill Road, Bridgewater, NJ 08807, U.S.A., Telephone: (1)908-231-0960, Fax: (1)908-231-1218

Germany: HAMAMATSU PHOTONICS DEUTSCHLAND GMBH: Arzbergerstr. 10, 82211 Herrsching am Ammersee, Germany, Telephone: (49)8152-375-0, Fax: (49)8152-265-8 E-mail: [info@hamamatsu.de](mailto:info@hamamatsu.de)

France: HAMAMATSU PHOTONICS FRANCE S.A.R.L.: 19 Rue du Saule Trapu, Parc du Moulin de Massy, 91882 Massy Cedex, France, Telephone: (33)1 69 53 71 00, Fax: (33)1 69 53 71 10 E-mail: [infos@hamamatsu.fr](mailto:infos@hamamatsu.fr)

United Kingdom: HAMAMATSU PHOTONICS UK LIMITED: 2 Howard Court, 10 Tewin Road, Welwyn Garden City, Hertfordshire, AL7 1BW, UK, Telephone: (44)1707-294888, Fax: (44)1707-325777 E-mail: [info@hamamatsu.co.uk](mailto:info@hamamatsu.co.uk)

North Europe: HAMAMATSU PHOTONICS NORDEN AB: Torshamnsgatan 35, 16440 Kista, Sweden, Telephone: (46)8-509-031-00, Fax: (46)8-509-031-01 E-mail: [info@hamamatsu.se](mailto:info@hamamatsu.se)

Italy: HAMAMATSU PHOTONICS ITALIA S.R.L.: Strada della Moia, 1 int. 6 20044 Arese (Milano), Italy, Telephone: (39)02-93 58 17 33, Fax: (39)02-93 58 17 41 E-mail: [info@hamamatsu.it](mailto:info@hamamatsu.it)

China: HAMAMATSU PHOTONICS (CHINA) CO., LTD.: 1201, Tower B, Jianning Center, 27 Dongsanhuan Beilu, Chaoyang District, 100020 Beijing, P.R. China, Telephone: (86)10-6586-6006, Fax: (86)10-6586-2866 E-mail: [hpc@hamamatsu.com.cn](mailto:hpc@hamamatsu.com.cn)

Taiwan: HAMAMATSU PHOTONICS TAIWAN CO., LTD.: 13F-1, No.101, Section 2, Gongdao 5th Road, East Dist., Hsinchu City, 300046, Taiwan(R.O.C) Telephone: (886)3-659-0080, Fax: (886)3-659-0081 E-mail: [info@hamamatsu.com.tw](mailto:info@hamamatsu.com.tw)