

S4810, S6289

Operation at low voltage from 2.2 V

The S4810 and S6289 are digital output photo ICs consisting of a photodiode, schmitt trigger circuit and output transistor, all integrated on a single chip and molded into a visible-cut, subminiature plastic package.

Features

- Low-voltage operation: 2.2 to 7 V
- Subminiature plastic package with lens
- Low current consumption
- Open collector output
- S4810: "H" level output at light input
S6289: "L" level output at light input

Applications

- Cameras
- Tape start/end mark sensor for VTRs, cassette tape recorders, etc.
- Optical switches
- Encoders

Absolute maximum ratings (Ta=25 °C)

Parameter	Symbol	Value	Unit
Supply voltage	Vcc	-0.5 to +7	V
Output voltage	Vo	-0.5 to +7	V
Output current	Io	8	mA
Power dissipation	P	150	mW
Operating temperature	Topr	-25 to +85	°C
Storage temperature	Tstg	-40 to +100	°C
Soldering	-	260 °C, 3 s, at least 2.5 mm away from package surface	-

Note: Exceeding the absolute maximum ratings even momentarily may cause a drop in product quality. Always be sure to use the product within the absolute maximum ratings.

Electrical and optical characteristics (Ta=25 °C, Vcc=5 V, light source: λp=890 nm LED, unless otherwise noted)

Parameter	Symbol	Condition	S4810			S6289			Unit
			Min.	Typ.	Max.	Min.	Typ.	Max.	
Supply voltage	Vcc		2.2	-	7.0	2.2	-	7.0	V
Low level output voltage	VOL	IoL=4 mA*1	-	-	0.4	-	-	0.4	V
High level output current	IOH	Vo=5 V*2	-	-	10	-	-	10	μA
Current consumption	Icc		-	1.3	3	-	1.3	3	mA
L→H Threshold illuminance	ELH	RL=1.2 kΩ	-	-	1.5	-	-	-	μW/mm ²
H→L Threshold illuminance	EHL	RL=1.2 kΩ	-	-	-	-	-	1.5	μW/mm ²
Hysteresis	-	*3	-	0.9	-	-	0.85	-	-
L→H Propagation delay time	tPLH	2 μW/mm ² RL=1.2 kΩ	-	-	10	-	-	15	μs
H→L Propagation delay time	tPHL		-	-	15	-	-	10	μs
Rise time	tr		-	0.07	-	-	0.07	-	μs
Fall time	tf		-	0.03	-	-	0.03	-	μs
Peak sensitivity wavelength	λp		-	850	-	-	850	-	nm

*1: S4810: E (illuminance) =0 μW/mm², S6289: E=2 μW/mm²

*2: S4810: E=2 μW/mm², S6289: E=0 μW/mm²

*3: S4810: EHL/ELH, S6289: ELH/EHL

Note: Connect a 0.01 μF capacitor or larger between Vcc and GND.

Response time measurement circuit

S4810

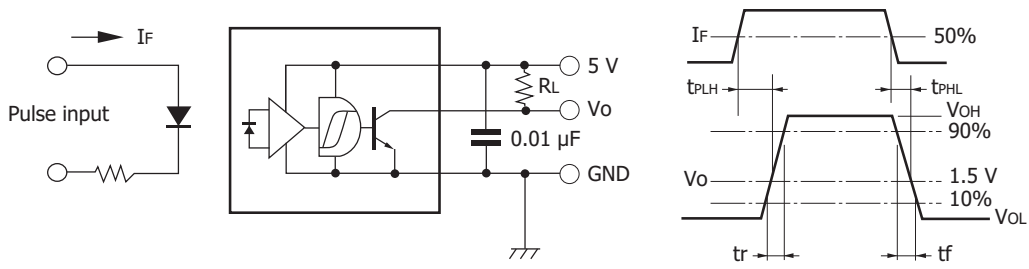

KPIC0005EA

S6289

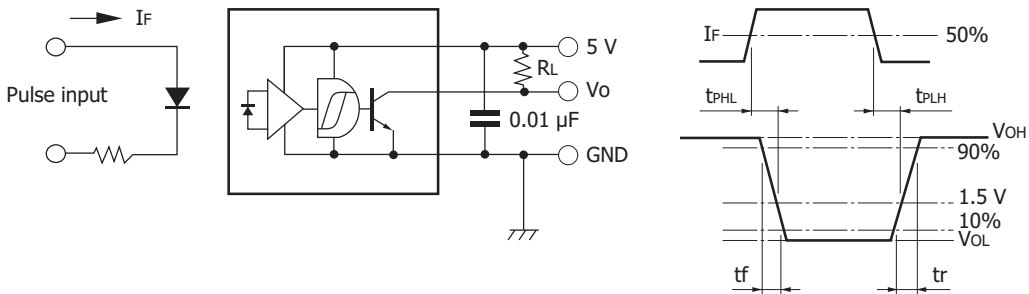

KPIC0038EC

Spectral response

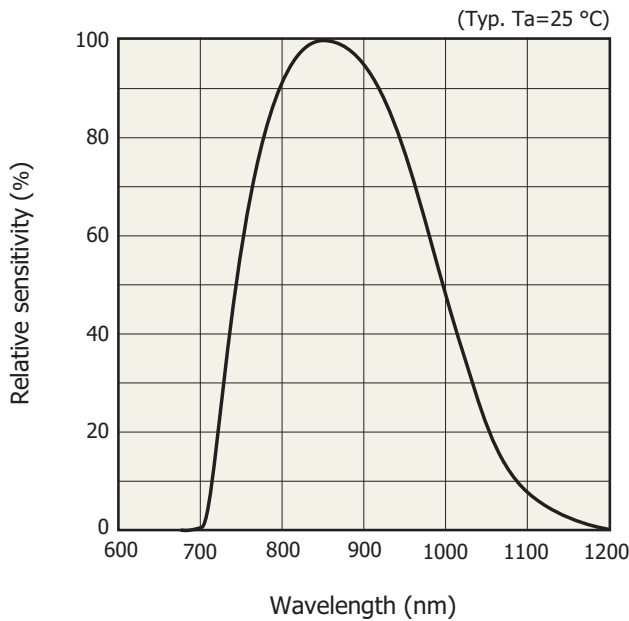

KPIC0004EB

Low level output voltage vs. low level output current

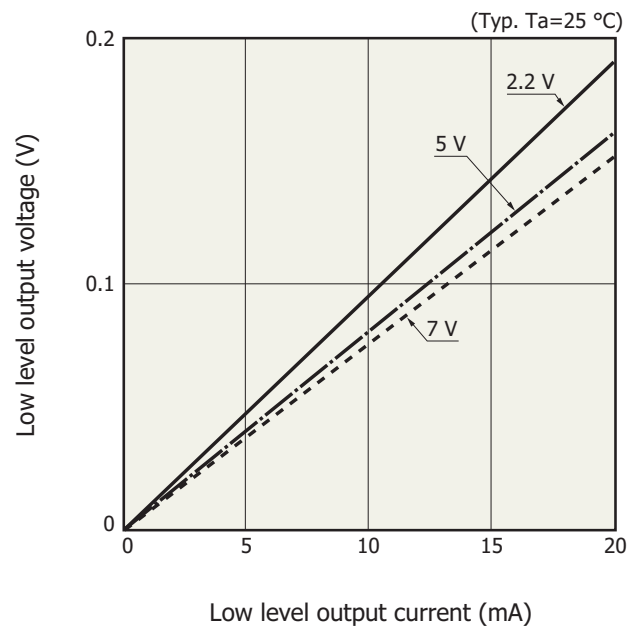

KPIC0005EA

Threshold illuminance vs. supply voltage

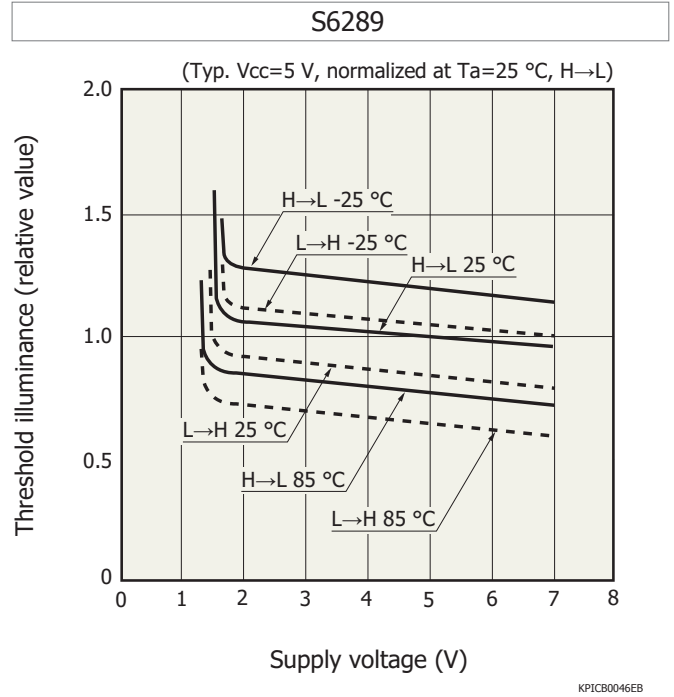
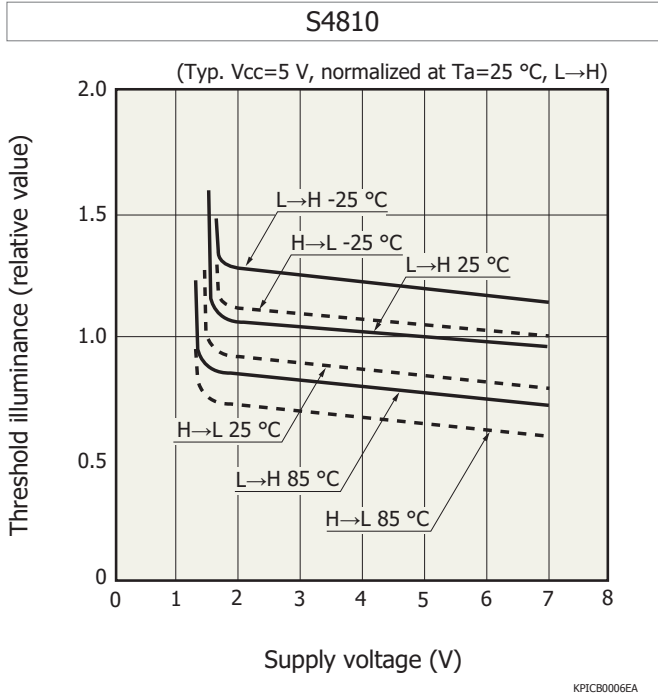

Supply current vs. ambient temperature

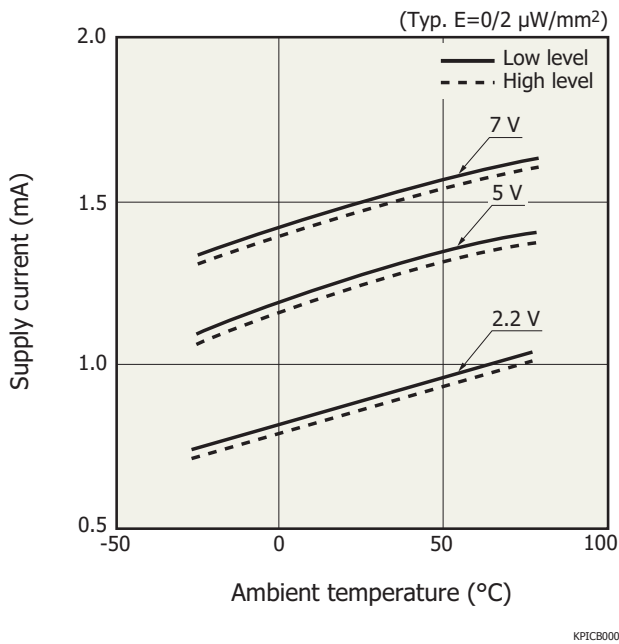

Low level output voltage vs. ambient temperature

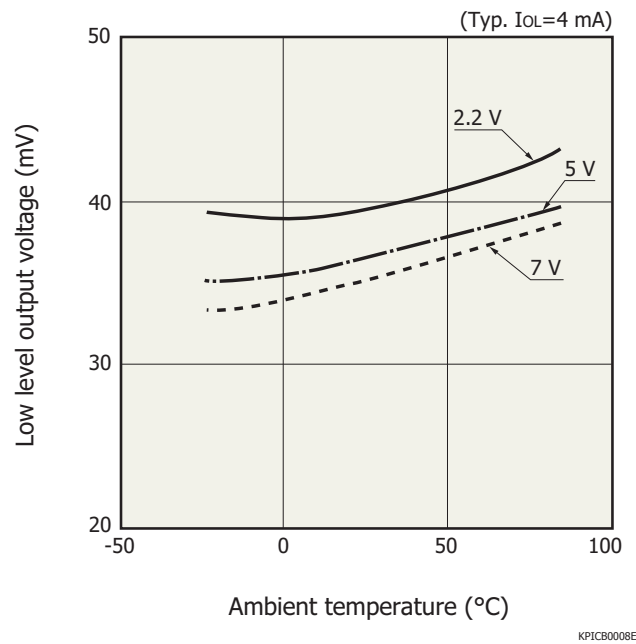

Threshold illuminance vs. ambient temperature

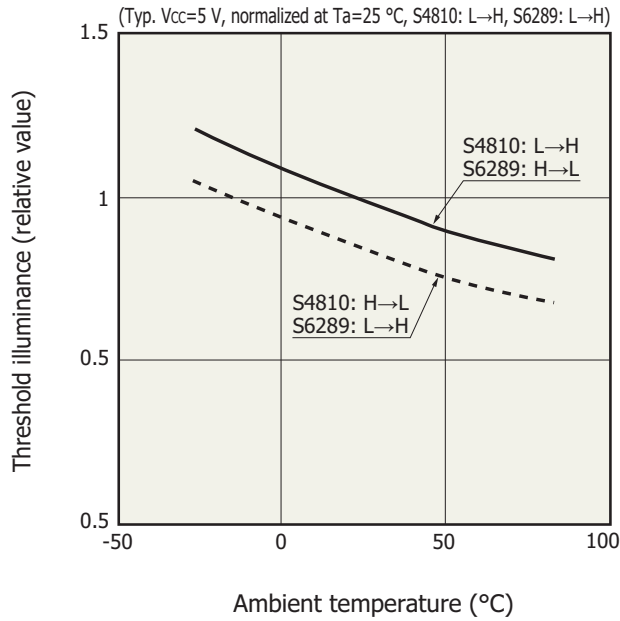

KPICB0009EA

Propagation delay time vs. input light strength

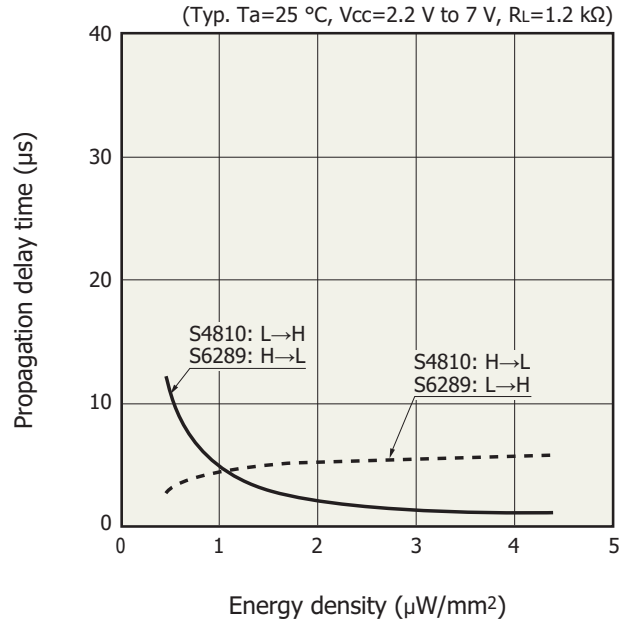

KPICB0010EB

Rise/fall time vs. load resistance

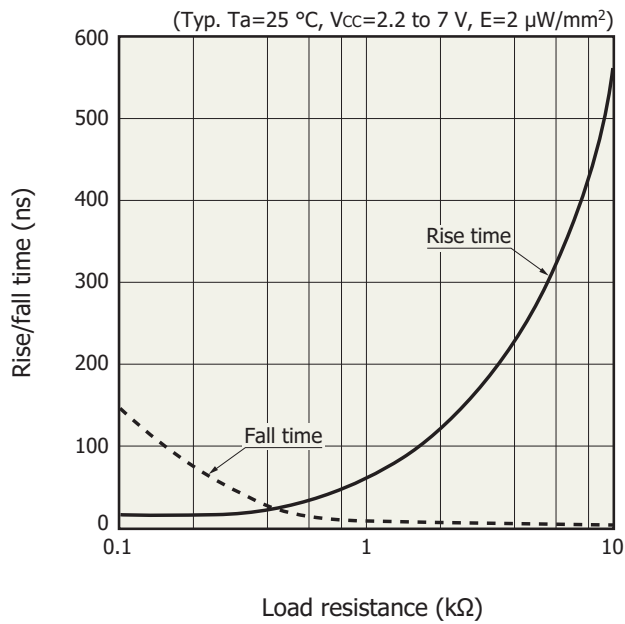

KPICB0011EB

Directivity

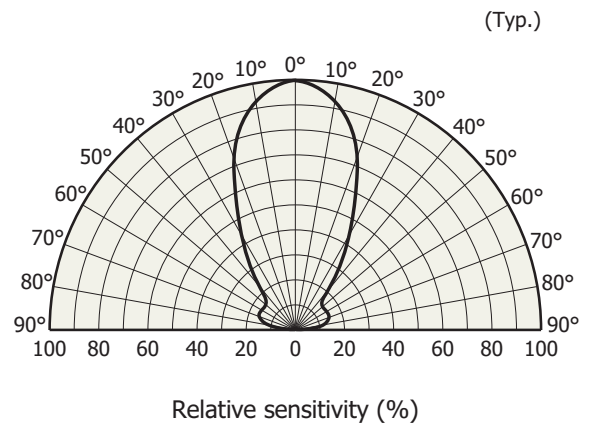

KPICB0012EB

Power dissipation vs. ambient temperature

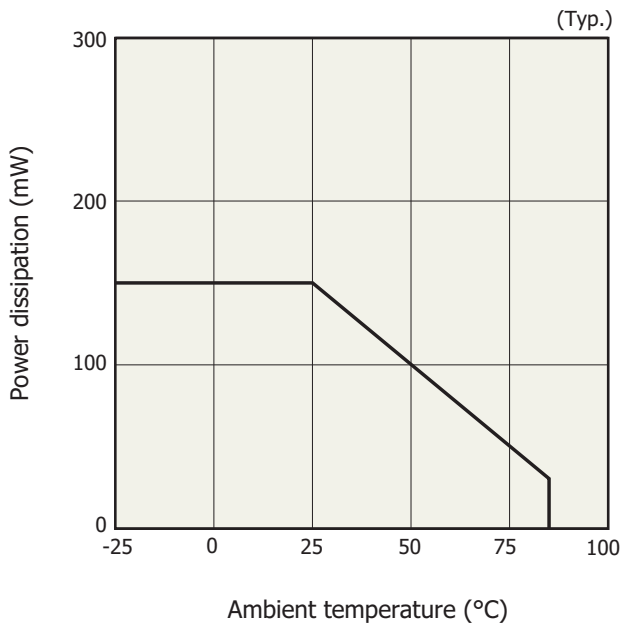

Dimensional outline (unit: mm)

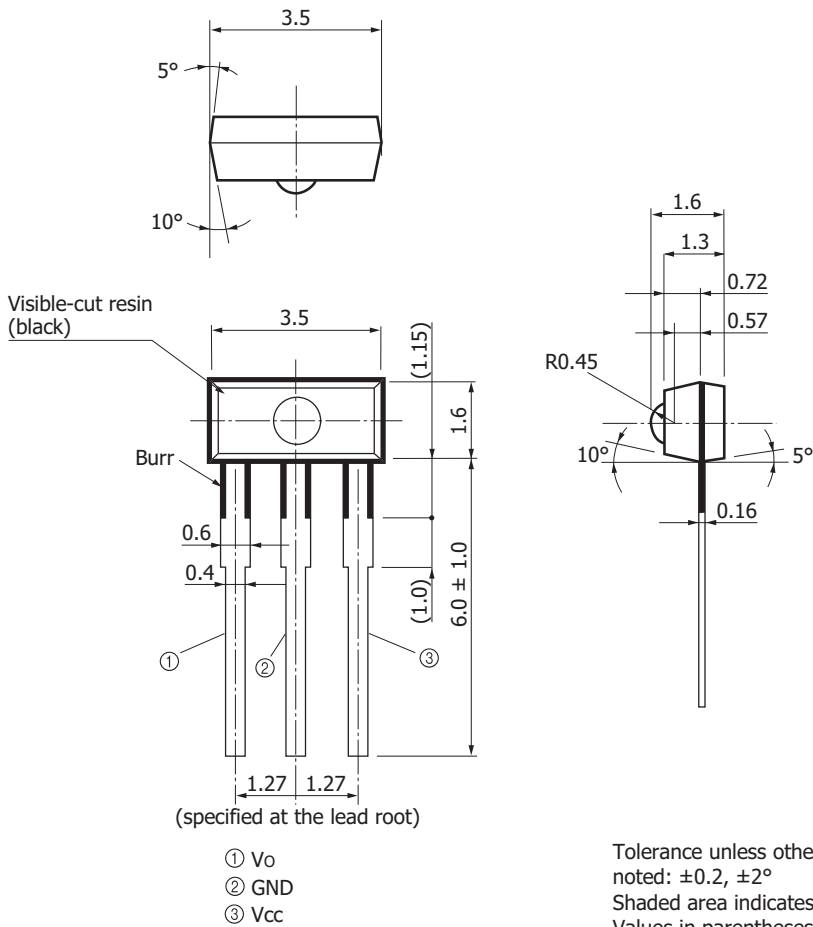

Related information

www.hamamatsu.com/sp/ssd/doc_en.html

■ Precautions

- Disclaimer
- Metal, ceramic, plastic products

Information described in this material is current as of October 2017.

Product specifications are subject to change without prior notice due to improvements or other reasons. This document has been carefully prepared and the information contained is believed to be accurate. In rare cases, however, there may be inaccuracies such as text errors. Before using these products, always contact us for the delivery specification sheet to check the latest specifications.

The product warranty is valid for one year after delivery and is limited to product repair or replacement for defects discovered and reported to us within that one year period. However, even if within the warranty period we accept absolutely no liability for any loss caused by natural disasters or improper product use. Copying or reprinting the contents described in this material in whole or in part is prohibited without our prior permission.

HAMAMATSU

www.hamamatsu.com

HAMAMATSU PHOTONICS K.K., Solid State Division

1126-1 Ichino-cho, Higashi-ku, Hamamatsu City, 435-8558 Japan, Telephone: (81) 53-434-3311, Fax: (81) 53-434-5184

U.S.A.: Hamamatsu Corporation: 360 Foothill Road, Bridgewater, N.J. 08807, U.S.A., Telephone: (1) 908-231-0960, Fax: (1) 908-231-1218, E-mail: usa@hamamatsu.com

Germany: Hamamatsu Photonics Deutschland GmbH: Arzbergerstr. 10, D-82211 Herrsching am Ammersee, Germany, Telephone: (49) 8152-375-0, Fax: (49) 8152-265-8, E-mail: info@hamamatsu.de

France: Hamamatsu Photonics France S.A.R.L.: 19, Rue du Saule Trapu, Parc du Moulin de Massy, 91882 Massy Cedex, France, Telephone: 33-(1) 69 53 71 00, Fax: 33-(1) 69 53 71 10, E-mail: infos@hamamatsu.fr

United Kingdom: Hamamatsu Photonics UK Limited: 2 Howard Court, 10 Tewin Road, Welwyn Garden City, Hertfordshire AL7 1BW, United Kingdom, Telephone: (44) 1707-294888, Fax: (44) 1707-325777, E-mail: info@hamamatsu.co.uk

North Europe: Hamamatsu Photonics Norden AB: Torshamnsgatan 35 16440 Kista, Sweden, Telephone: (46)8-509 031 00, Fax: (46)8-509 031 01, E-mail: info@hamamatsu.se

Italy: Hamamatsu Photonics Italia S.r.l.: Strada della Moia, 1 int. 6, 20020 Arese (Milano), Italy, Telephone: (39)02-93 58 17 33, Fax: (39)02-93 58 17 41, E-mail: info@hamamatsu.it

China: Hamamatsu Photonics (China) Co., Ltd.: B1201, Jiaming Center, No.27 Dongsanhuan Beilu, Chaoyang District, Beijing 100020, China, Telephone: (86) 10-6586-6006, Fax: (86) 10-6586-2866, E-mail: hpc@hamamatsu.com.cn

Taiwan: Hamamatsu Photonics Taiwan Co., Ltd.: 8F-3, No. 158, Section2, Gongdao 5th Road, East District, Hsinchu, 300, Taiwan R.O.C. Telephone: (886)03-659-0080, Fax: (886)03-659-0081, E-mail: info@tw.hpj.co.jp