

NEW



SPEED
EXPLORATION

3.5x

ORCA[®]-Lightning

Digital CMOS camera C14120-20P



HAMAMATSU
PHOTON IS OUR BUSINESS

ORCA-Lightning

Inspiration does not obey speed limits.

For imaging scientists, inspiration is often found at the edges—at the spatial, temporal, and optical boundaries of a system. It's that grainy image of the cytoskeleton that has just enough photons to confidently resolve two unique molecules. It's data extracted from a few pixels, whittled away from a larger array, to achieve capture rates relevant to neuronal signaling. It's the mesmerizing cellular migrations of a developing embryo, reconstructed from a lightsheet time-lapse, that offer new insights and spark new questions.

By more than doubling speed, resolution and field of view relative to current scientific cameras, the ORCA-Lightning is designed to inspire new frontiers of exploration. Compared to a Gen II sCMOS, the ORCA-Lightning delivers 2 times the pixel area, 2.8 times the pixels and 3.4 times faster pixel-per-second readout.

All these increases translate to the ability to capture more image data faster, and still achieve Hamamatsu-quality images and information content. So whether you're developing the next cutting-edge lightsheet system or building a library of the mouse connectome, the high throughput of the ORCA-Lightning will get you to your goal faster. And, we hope, open doors to new discoveries.

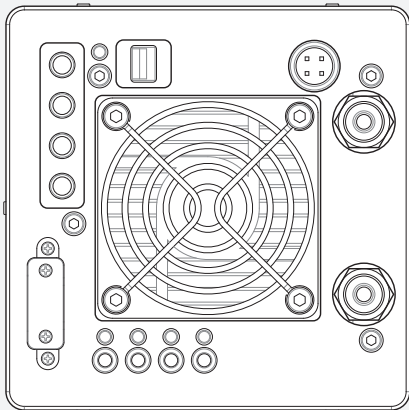
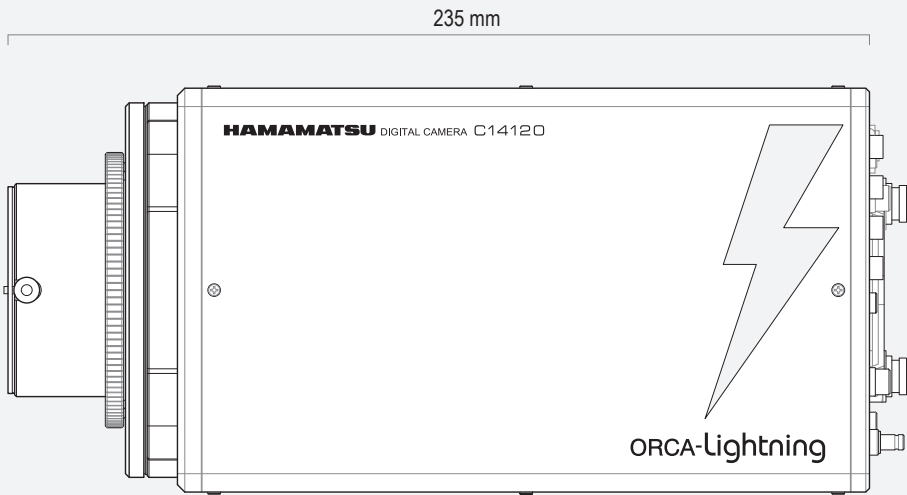
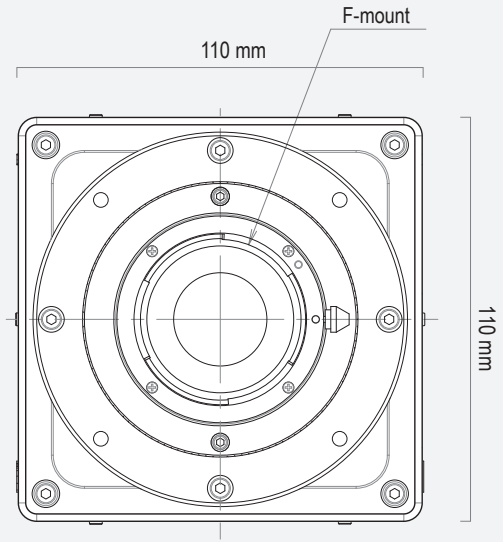

Weight: Approx. 3.6 kg

SPEED

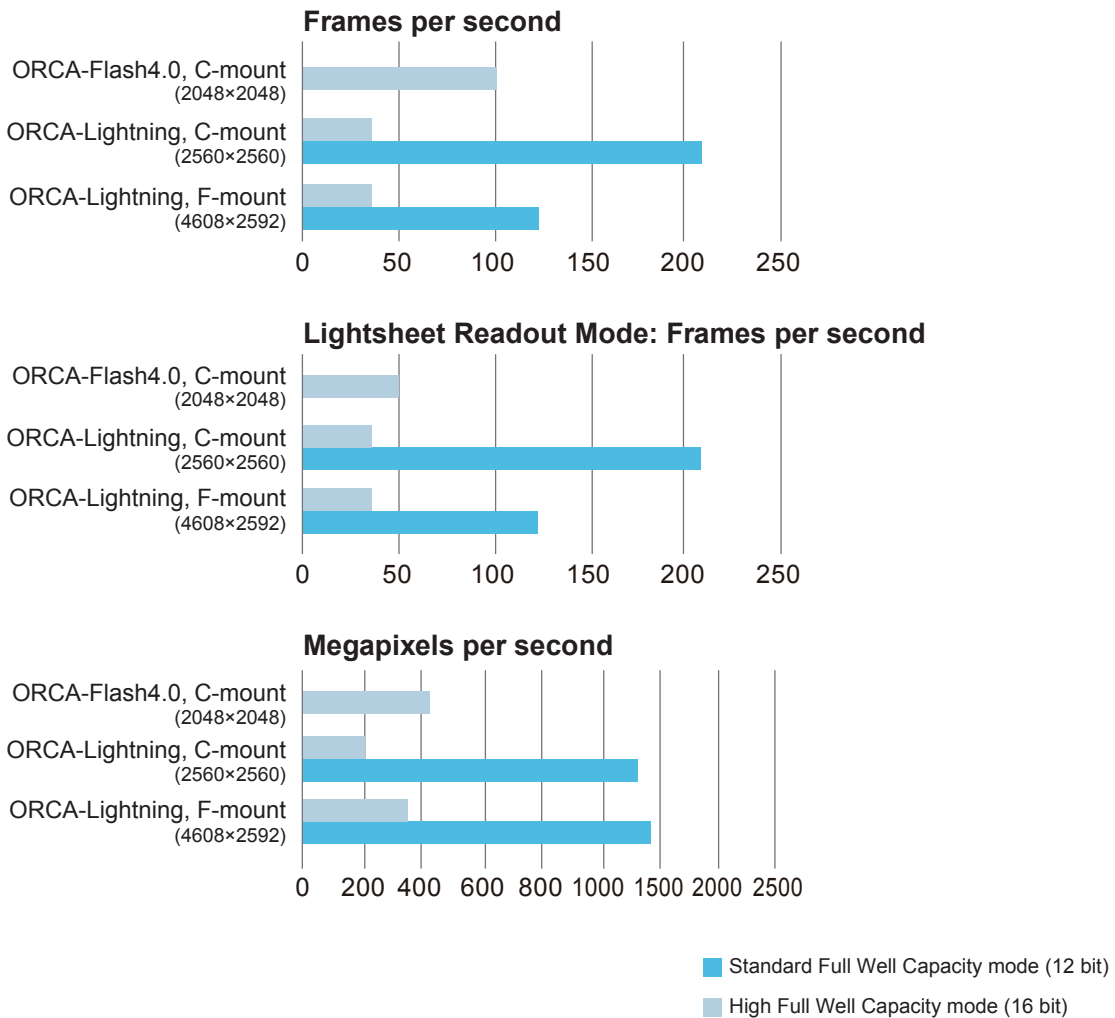

No matter how you slice it, the ORCA-Lightning is fast. If you need a maximum field of view (4608 x 2592) as fast as possible, the ORCA-Lightning can output as high as 121 frames per second, or 1445 megapixels per second. Using a subarray of 512 x 512 pixels increases frame rates to a galloping 1201. The ORCA-Lightning uses a state-of-art CoaXPress interface to optimize high speed data acquisition. The ORCA-Lightning includes our now patented, Lightsheet Readout Mode which takes advantage of sCMOS rolling shutter readout to enhance the quality of lightsheet images. And, our engineers can work with you to ensure your acquisition system is optimized for speed.

FOV

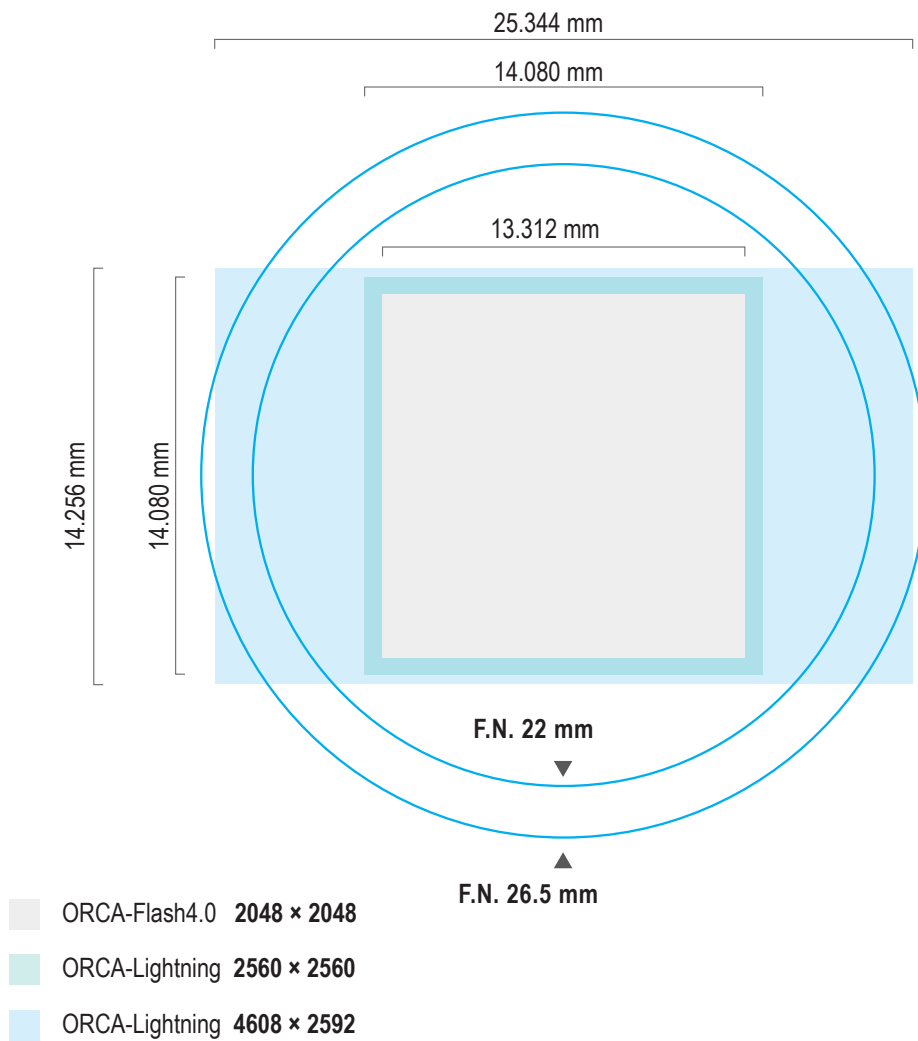

The ORCA-Lightning is big without requiring big trade-offs. This 12MP camera can deliver a 4 mm longitudinal field of view with 1 μm resolution and still offer speed, low noise and attention to the details that keep data quantitative. Capturing more data per image can have big advantages: fewer images per sample, less stitching and stage movement, more pixels for statistical methods and for methods that optically divide the sensor. Although the speed of the ORCA-Lightning is its headline feature, just having lots of high performance pixels might be the perfect tool for your next innovation.

READOUT MODES

Normal Area Mode

4 horizontal lines are read concurrently.

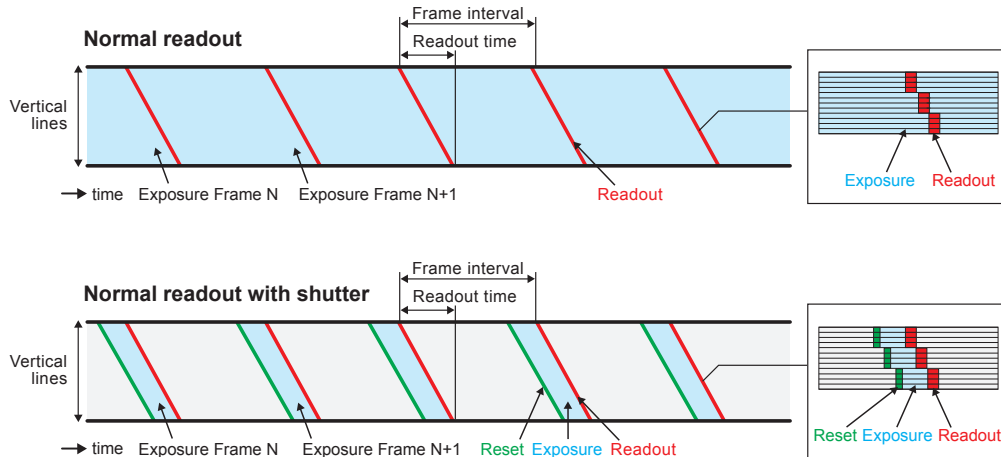

Lightsheet Readout Mode

4 horizontal lines are read concurrently.

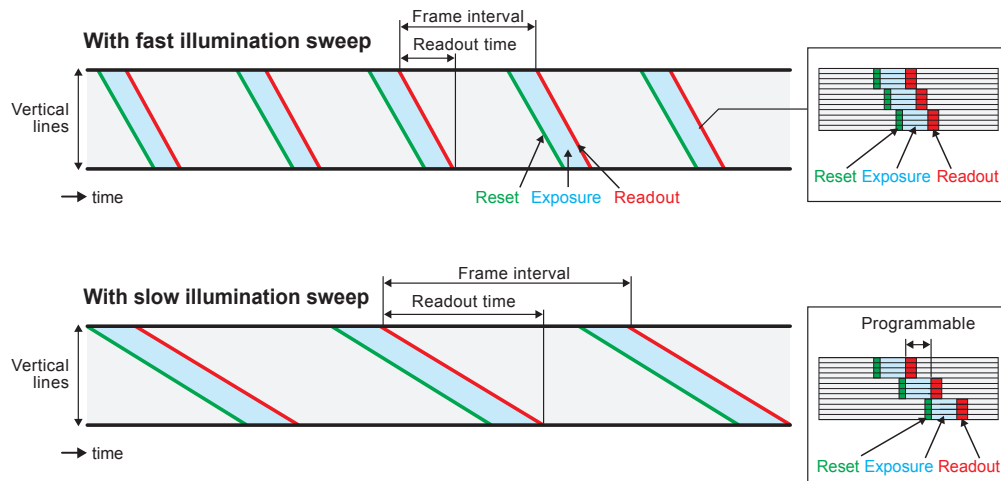

Engineered with high speed, large field of view experiments in mind, the ORCA-Lightning employs a unique readout method allowing it to achieve unmatched frame rates. By concurrently reading four lines at a time, image data is streamed at up to 121 full frames (4608 x 2592) per second using Hamamatsu's patented Lightsheet Readout Mode.

ORCA-Lightning SPECIFICATIONS

Product number		C14120-20P	
Full Well Capacity mode		Standard Full Well Capacity mode	High Full Well Capacity mode
Imaging device		Scientific CMOS image sensor	
Effective number of pixels		4608 (H) × 2592 (V)	
Pixel size		5.5 μm (H) × 5.5 μm (V)	
Effective area		25.344 mm (H) × 14.256 mm (V)	
Quantum efficiency	at 550 nm	Over 60 %	
Full well capacity (Typ.)		1000 electrons	38 000 electrons
Readout noise (Typ.)		1.5 electrons median / 2.0 electrons rms	2.2 electrons median / 2.7 electrons rms
Dark current (Typ.)	Air cooled (cooling temperature: +20 °C)	15 electrons	
Linearity error *1	EMVA 1288 standard	1 % or less	
	< 500 electrons signal	1 % or less	
Photo Response Non-Uniformity (PRNU) *1		–	3 % or less (at 20 000 electrons signal)
Dark Signal Non-Uniformity (DSNU) *1		0.5 electrons r.m.s.	
Dynamic range (Typ.)		650 : 1	17 000 : 1
Cooling temperature	Forced-air cooled (Ambient temperature: +25 °C)	+20 °C	
	Water cooled	+20 °C	
Interface		CoaXPress-6×4 lane	
Digital output		12 bit	16 bit
Exposure time	Internal trigger mode/Full resolution	6.304 μs to 1 s	50.432 μs to 1 s
Binning		2×2, 4×4	
Sub-array		Yes	
Readout mode		Normal readout mode / Lightsheet readout mode	
Lightsheet readout mode	Readout time (4608×2592)	8.2 ms to 129.6 ms *2	32.7 ms to 129.6 ms *3
	Minimum readout interval (4608×2592)	8.3 ms	32.7 ms
	Readout mode	Full area / Sub-array	
	Readout direction	Forward direction	
External trigger input mode		Edge trigger, Global reset edge trigger, Level trigger, Global reset level trigger, Synchronous readout trigger, Start trigger	
Trigger input connector		SMA	
Trigger delay function		0 s to 10 s in 1 μs steps	
Ambient operating temperature	Forced-air cooled (With no condensation)	0 °C to +40 °C	
Ambient operating humidity		30 % to 80 %	

*1 Typical value

*2 Setting range of 4H: 12.608 μs to 200 μs

*3 Setting range of 4H: 50.432 μs to 200 μs

CAMERA SPECS

HIGH RESOLUTION

4608 x 2592

12 Megapixels

HIGH SPEED

121 frames/s

at full resolution

READ NOISE

2.0 electrons rms

Standard Full Well Capacity mode

PIXEL SIZE

5.5 μm

DYNAMIC RANGE

17 000:1

High Full Well Capacity mode

PEAK QE (Typ.)

60 %

Lightsheet Readout Mode

Large Field of View

3.4 times the pixel throughput of Gen II sCMOS

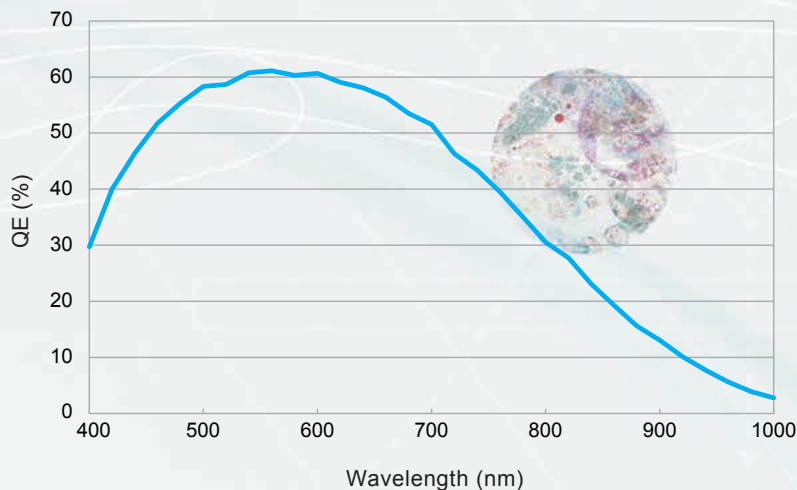

ORCA is registered trademark of Hamamatsu Photonics K.K. (France, Germany, Japan, U.K., U.S.A.)

Product and software package names noted in this documentation are trademarks or registered trademarks of their respective manufacturers.

● Subject to local technical requirements and regulations, availability of products included in this promotional material may vary. Please consult your local sales representative.

● Information furnished by HAMAMATSU is believed to be reliable. However, no responsibility is assumed for possible inaccuracies or omissions.

● Specifications and external appearance are subject to change without notice.

© 2019 Hamamatsu Photonics K.K.

HAMAMATSU PHOTONICS K.K. www.hamamatsu.com

HAMAMATSU PHOTONICS K.K., Systems Division

812 Joko-cho, Higashi-ku, Hamamatsu City, 431-3196, Japan, Telephone: (81)53-431-0124, Fax: (81)53-433-8031, E-mail: export@sys.hpk.co.jp

U.S.A.: Hamamatsu Corporation: 360 Foothill Road, Bridgewater, NJ 08807, U.S.A., Telephone: (1)908-231-0960, Fax: (1)908-231-1218 E-mail: usa@hamamatsu.com

Germany: Hamamatsu Photonics Deutschland GmbH: Arzbergerstr. 10, D-82211 Herrsching am Ammersee, Germany, Telephone: (49)8152-375-0, Fax: (49)8152-265-8 E-mail: info@hamamatsu.de

France: Hamamatsu Photonics France S.A.R.L.: 19, Rue du Saule Trapu, Parc du Moulin de Massy, 91882 Massy Cedex, France, Telephone: (33)1 69 53 71 00, Fax: (33)1 69 53 71 10 E-mail: infos@hamamatsu.fr

United Kingdom: Hamamatsu Photonics UK Limited: 2 Howard Court, 10 Tewin Road, Welwyn Garden City, Hertfordshire AL7 1BW, UK, Telephone: (44)1707-294888, Fax: (44)1707-325777 E-mail: info@hamamatsu.co.uk

North Europe: Hamamatsu Photonics Norden AB: Torshamnsgatan 35 16440 Kista, Sweden, Telephone: (46)8-509 031 00, Fax: (46)8-509 031 01 E-mail: info@hamamatsu.se

Italy: Hamamatsu Photonics Italia S.r.l.: Strada della Moia, 1 int. 6, 20020 Arese (Milano), Italy, Telephone: (39)02-93 58 17 33, Fax: (39)02-93 58 17 41 E-mail: info@hamamatsu.it

China: Hamamatsu Photonics (China) Co., Ltd.: 1201 Tower B, Jiaming Center, 27 Dongsanhuan Beilu, Chaoyang District, 100020 Beijing, P.R.China, Telephone: (86)10-6586-6006, Fax: (86)10-6586-2866 E-mail: hpc@hamamatsu.com.cn

Taiwan: Hamamatsu Photonics Taiwan Co., Ltd.: 8F-3, No.158, Section2, Gongdao 5th Road, East District, Hsinchu, 300, Taiwan R.O.C. Telephone: (886)3-659-0080, Fax: (886)3-659-0081 E-mail: info@hamamatsu.com.tw

Cat. No. SCAS0132E01
JUN/2019 HPK
Created in Japan